

33-4

~~D-10122~~

~~15540~~

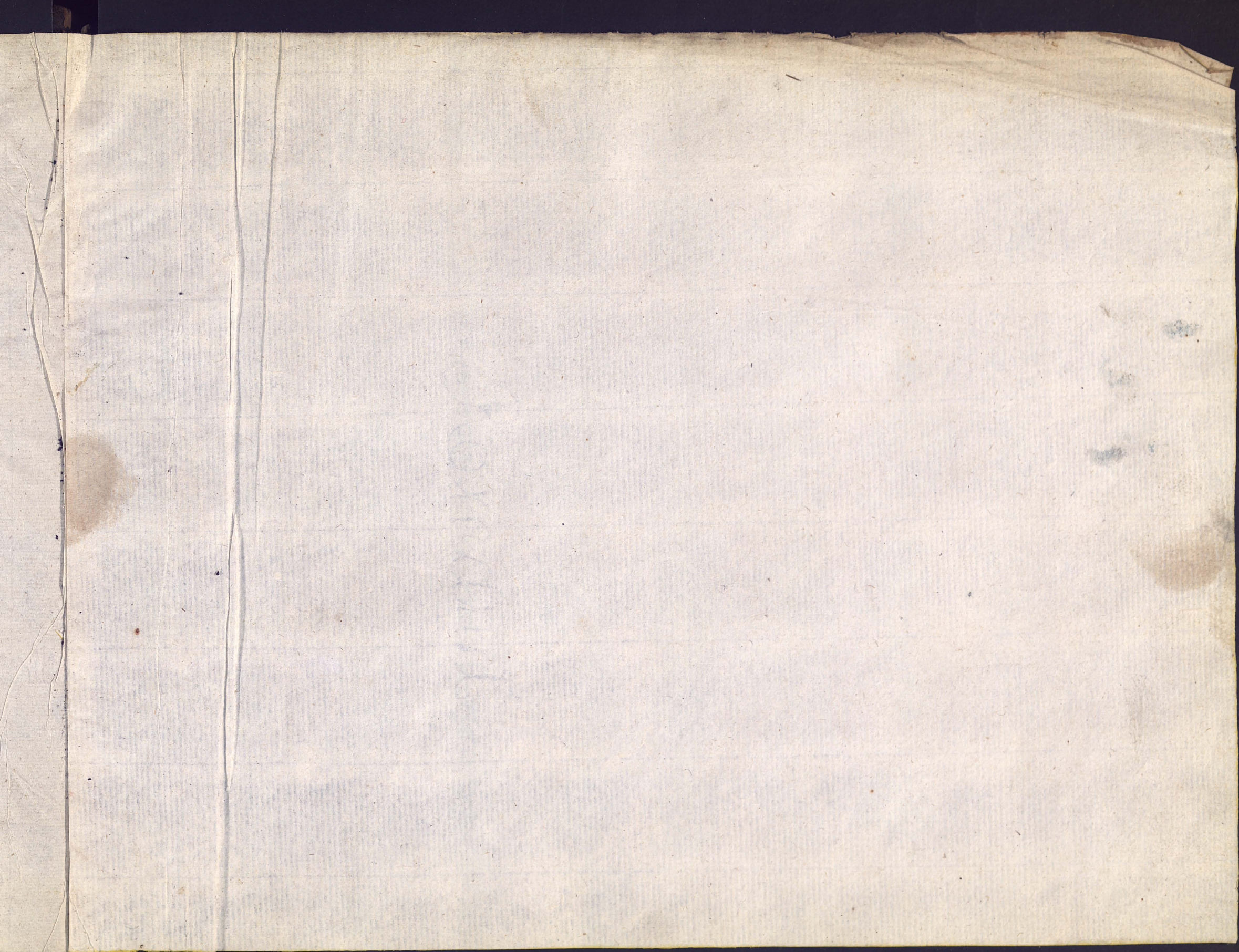

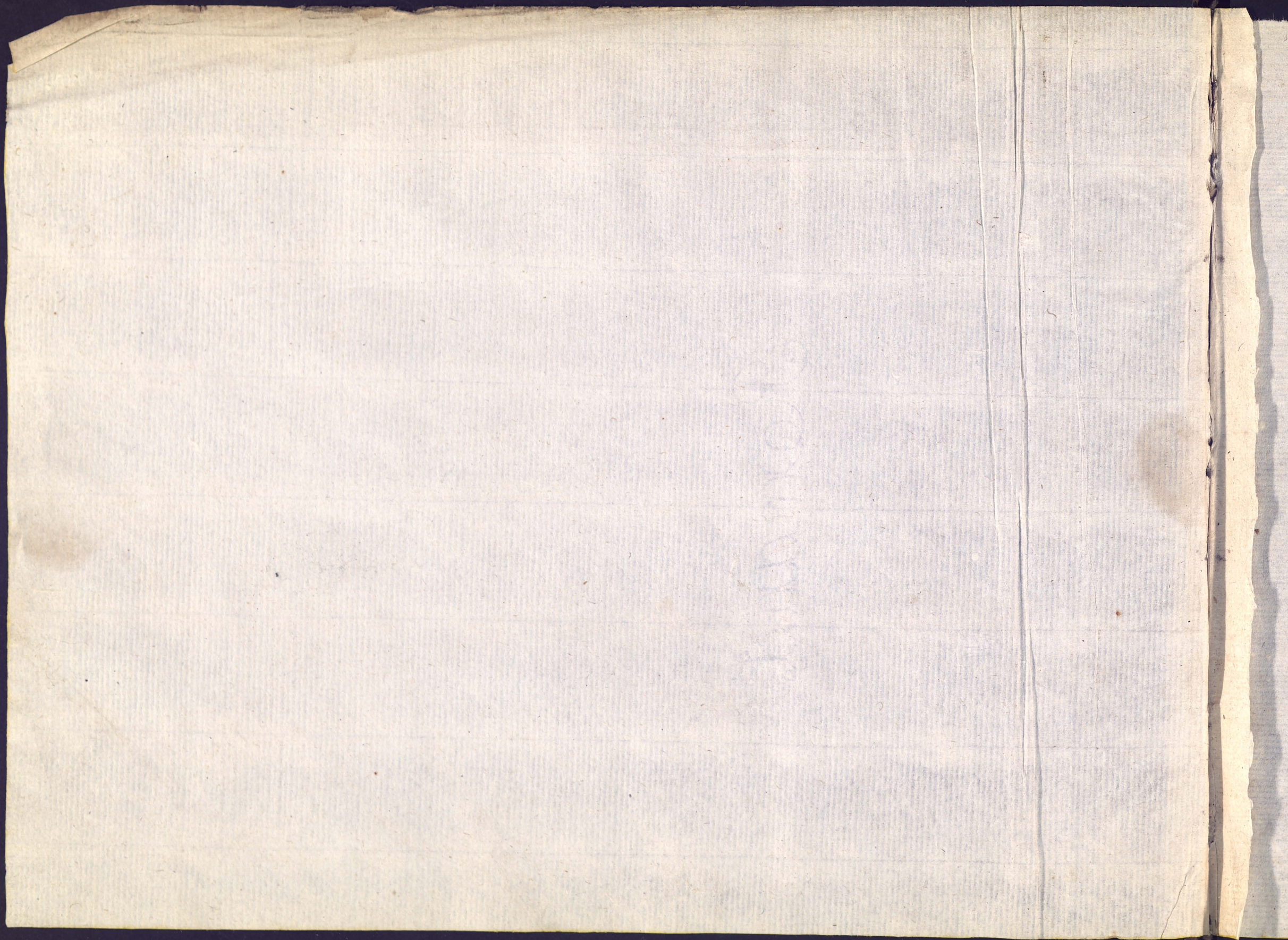

TRAITÉ DE MINÉRALOGIE,

PAR LE C^{EN}. HAÜY,

Membre de l'Institut National des Sciences et Arts, et Conservateur
des Collections Minéralogiques de l'École des Mines.

PUBLIÉ PAR LE CONSEIL DES MINES.

TOME CINQUIÈME.

*Caractères Minéralogiques. Distribution méthodique des Minéraux.
Figures Géométriques.*



A PARIS,

CHEZ LOUIS, LIBRAIRE, RUE DE SAVOYE, N^o. 12.

(x) 1801.

TRAITÉ DE MINÉRALOGIE

PAR L'ÉCOLE NATIONALE

Membre de l'Institut National des Sciences et des Lettres
des Collections Numériques de la Bibliothèque Nationale

PUBLIÉ PAR LE GOUVERNEMENT

TOME CINQUIÈME

Paris chez les Libraires, Rue de la Harpe, N. 105



PARIS

CHEZ TOUS LES LIBRAIRES RUE DE LA HARPE N. 105

CARACTÈRES
MINÉRALOGIQUES.

SYSTÈME DE CARACTÈRES

RELATIFS

AUX MINÉRAUX.

PHYSIQUE GÉNÉRALE.

- | | | | | | | |
|--------------------|--------------------------|-----------------------------------|---|---|----------------------|---|
| PHYSIQUE GÉNÉRALE. | 1. Pesanteur spécifique. | Usage de la balance de Nickolson. | 1. Par le frottement de la lime. | 1. Les corps durs résistent. La télésie. | | |
| | | | 2. Par le frottement des parties anguleuses d'un corps sur la surface d'un autre. | 2. Les corps tendres cèdent. La chaux carbonatée. | | |
| | | | 3. Par la percussion du marteau. | La télésie raye le quartz. | | |
| | | | 4. Par le choc du briquet. | 1. Difficiles à briser. L'émeril. | | |
| | | | 5. Par la flexion ou par la pression. | 2. Fragiles. Le soufre. | | |
| | | | 6. Par la force de traction. | 3. Friables, qui s'égrènent aisément. Certains grès. | | |
| | 2. Consistance. | 1. Dans les solides éprouvés. | 2. Dans les liquides. | 1. Étincelans. Le quartz. | CORPS. CORPS. CORPS. | |
| | | | | 2. Non étincelans. La chaux fluatée. | | 1. Simplement flexibles. Le talc laminaire. |
| | | | | 3. Ductiles. L'or, l'argent, etc. | | 2. Élastiques. Le mica. |
| | | | | 4. Mous. { 1. Dans l'état naturel. Le bitume glutineux. | | 3. Fragiles. Le soufre. |
| | | | | 2. Après l'imbibition. L'argile. | | 3. Friables, qui s'égrènent aisément. Certains grès. |
| | | | | Facilité de céder à la plus légère pression. | | CORPS doués de ténacité. L'or, l'argent, le fer, etc. |

I. CARACTÈRES PHYSIQUES.

PHYSIQUE PARTICULIÈRE.

3. Impression sur la langue.	1. Saveur.	1. Salée. La soude muriatée. 2. Astringente. Le fer sulfaté. 3. Douceâtre. L'alumine sulfatée. 4. Fraîche. La potasse nitratée. 5. Amère. La magnésie sulfatée. 6. Urineuse et piquante. L'ammoniaque muriaté. Quelques argiles, le quartz-résinite hydrophane.	
4. Impression sur le tact.	2. Happement. Surface ou poussière. 1. Onctueuse au toucher. Le talc. 2. Douce (sans onctuosité). L'asbeste flexible. 3. Aride. Le feld-spath argiliforme (kaolin).		
5. Odeur.	1. Par la vapeur de l'haleine. Quelques argiles. 2. Par le frottement. La chaux carbonatée fétide (pierre de porc). 3. Par le feu.	1. D'ail. L'arsenic. 2. Bitumineuse. La houille. 3. Sulfureuse. Le soufre.	
6. Son.	1. Par la percussion. L'ardoise, les métaux. 2. Par la flexion. Cri de l'étain.		
7. Lumière.	1. Leurs espèces. Rouge, jaune, vert, bleu, etc.		
	I. Couleurs de la masse. } 2. Leur distribution.	1. Uniforme. L'émeraude verte, le quartz-agathe cornaline, etc. 2. Variée. { 1. Par taches. Les marbres secondaires. 2. Par bandes. Le quartz-agathe onyx.	
	3. Leur jeu.	1. Par chatoyement. Le feld-spath nacré. 2. Par reflets irisés. Le quartz-agathe opalin.	
	2. Couleur de la rapure.	1. Similaire ou la même que celle de la masse. L'argent antimonié sulfuré. 2. Dissimilaire. Le mica donne une poussière blanchâtre.	
1. Par réflexion. } 3. Couleur de la tachure.	1. Similaire. Le fer carburé. 2. Dissimilaire. Le molybdène sulfuré tache la porcelaine en vert.		
4. Éclat de la surface.	1. Brillante. Le quartz-hyalin. 2. Terne. Le quartz-jaspe. 3. Onctueuse à l'œil. Le jade poli. 4. Soyeuse. La chaux sulfatée fibreuse. 5. Nacrée. La stilbite. 6. Ayant le brillant métallique. L'or natif. 7. N'en ayant que l'apparence. Le mica argentin.		
	2. Par réfraction. } 1. Transparence.	1. Corps limpides; transparents et sans couleur. La télésie, dite <i>saphir blanc</i> . 2. Corps transparents avec couleur. Le spinelle. 3. Corps translucides, qui laissent passer trop peu de lumière pour permettre de rien distinguer à travers leur masse. Le quartz, dit <i>agate orientale</i> . 4. Corps opaques. L'or, l'argent, etc., à l'état natif.	
		2. Routes de la lumière.	1. Simple. La télésie. 2. Double. La chaux carbonatée.
		3. Par phosphorescence.	1. A l'aide du feu. La chaux phosphatée. 2. A l'aide du frottement. Le quartz gras, la grammatite.
8. Électricité.		1. Passive.	1. Par communication. } Les métaux à l'état métallique. 2. Par frottement. } 1. Vitrée. La plupart des substances terreuses. 2. Résineuse. Le soufre, le succin. 3. Par chaleur. } Vitrée d'un côté et résineuse de l'autre. La tourmaline, la mésotype.
	2. Active, ou communiquée à la cire d'Espagne, à l'aide du frottement.	1. Vitrée. Le molybdène sulfuré. 2. Résineuse. La plupart des minéraux. 3. Nulle. Le fer carburé.	
	9. Magnétisme.	1. Simple.	Attraction sur chaque pôle du barreau aimanté. La cornéenne.
2. Polaire.		Attraction sur un pôle et répulsion sur l'autre. Presque tous les cristaux de fer.	

II. CARACTÈRES GÉOMÉTRIQUES.

- | | | | | |
|--|---|--|---|---|
| 1. Formes. | 1. Déterminables.
2. Indéterminables.
3. Imitatives. | 1. Élémentaires. | 1. Noyau ou forme primitive.
2. Molécule intégrante.
3. Molécule soustractive. | |
| | | 2. Secondaires. | 1. Leurs lois de décroissemens.
2. Mesures de leurs angles. | |
| | | 1. Arrondissemens des faces et des angles.
2. Stries et aspérités.
3. Corps amorphes. D'une forme tout à fait irrégulière. | | |
| 2. Structure. Tissu d'un minéral dépendant de l'aggrégation des molécules ou du groupement des parties. | 3. Imitatives. | 1. Corps concrétionnés; coniques, cylindriques, globuleux, etc. | | |
| | | 2. Pseudomorphoses; corps qui ont pris la forme d'un autre corps auquel ils se sont substitués. | | |
| | | 1. Laminaire; offrant des lames continues. | NATURELS
JOINTS | 1. Également nets en tout sens. La chaux carbonatée. |
| | | | | 2. Plus nets dans un sens que dans l'autre. La chaux sulfatée. |
| | | | | 3. Sensibles seulement par le chatoyement à une vive lumière. Le plomb carbonaté. |
| | | 2. Lamellaire; offrant de petites lames, souvent inclinées en divers sens. | L'amphibole en masse. | |
| | | 3. Stratiforme; par couches non séparables. | Certains quartz-agathes. | |
| | | 4. Feuilletée; par couches séparables. | Le talc, dit <i>craie de Briançon</i> . | |
| | | 5. Fibreuse. | 1. A fibres parallèles. La chaux sulfatée, dite <i>soyeuse</i> .
2. Radiée, ou à fibres divergentes. La baryte sulfatée, dite <i>Pierre de Bologne</i> . | |
| | | | | 6. Granuleuse. |
| 7. Compacte; formée de parties indiscernables à l'œil. | 1. A fibres parallèles. La chaux sulfatée, dite <i>soyeuse</i> .
2. Radiée, ou à fibres divergentes. La baryte sulfatée, dite <i>Pierre de Bologne</i> . | | | |
| | | 8. Cellulaire. | Le quartz-jaspé. | |
| 3. Cassure. Manière dont les portions d'un minéral se séparent, lorsque la division ne suit point l'ordre de la structure. | 1. Ses directions.
2. Ses accidens. | 1. Longitudinale; ayant lieu parallèlement à l'axe des cristaux. La topaze. | | |
| | | 2. Transversale; ayant lieu perpendiculairement à l'axe des cristaux. L'amphibole. | | |
| | | 3. Indéfinie; ayant lieu dans tous les sens. Le quartz-agathe. | | |
| | | 1. Conchoïde; par concavités et convexités. Le quartz. | | |
| | | 2. Lisse. Le pléonaste. | | |
| 3. Raboteuse. L'argile. | | | | |
| 4. Écailleuse. Le quartz-agathe prase. | | | | |
| 5. Articulée. Une face convexe emboîtée dans une face concave, par la fracture faite à un cristal prismatique. La tourmaline. | | | | |

III. CARACTÈRES
CHIMIQUES.

- | | | | |
|--|--|--|---|
| 1. Par le feu. . . | 1. Au chalu-
meau. . . | 1. Fusibilité. | 1. Sans addition. Le grenat, le feld-spath. |
| | | 2. Résultat de la fusion. | 2. Seulement avec addition. La topaze, le zircon. |
| 2. Par les acides
et en particu-
lier par l'acide
nitrique. | 2. Sur les
charbons
ardens. . . | 3. Réduction des substances métalliques. . . | 1. Verre. La tourmaline. |
| | | 1. Volatilité. L'ammoniaque muriaté. | 2. Email. Le feld-spath. |
| 3. Par les alkalis | 1. Dissolution avec effervescence. La chaux carbonatée. | 2. Détonnation avec un corps combustible. La potasse nitratée. | 3. Masse spongieuse. La mésotype. |
| | | 2. Dissolution sans effervescence. La chaux phosphatée. | L'argent antimonial, l'argent sulfuré, le plomb carbonaté, etc. |
| | 3. Réduction en gelée. Le zinc oxydé. | 4. Bouillonnement. L'alumine sulfatée. | |
| | 1. La dissolution du cuivre par l'ammoniaque est d'un beau bleu. | | |
| | 2. La vapeur du sulfure ammoniacal noircit le plomb carbonaté. | | |

THE UNIVERSITY OF CHICAGO
LIBRARY

DISTRIBUTION MÉTHODIQUE
DES MINÉRAUX,

PAR CLASSES, ORDRES, GENRES ET ESPÈCES.

PREMIÈRE CLASSE.

Substances acidifères composées d'un acide uni à une terre ou à un alcali, et quelquefois à l'un et à l'autre.

PREMIER ORDRE.

Substances acidifères terreuses.

PREMIER GENRE.

CHAUX.

Première espèce.

Chaux carbonatée.

APPENDICE.

Chaux carbonatée unie à différentes substances, de manière à conserver sa structure, ou quelque autre de ses principaux caractères.

1. Chaux carbonatée aluminifère.
2. Chaux carbonatée ferrifère.
3. Chaux carbonatée quartzifère.

4. Chaux carbonatée magnésifère.

5. Chaux carbonatée fétide.

6. Chaux carbonatée bituminifère.

Seconde espèce.

Chaux phosphatée.

Troisième espèce.

Chaux fluatée.

Quatrième espèce.

Chaux sulfatée.

Cinquième espèce.

Chaux nitratée.

Sixième espèce.

Chaux arseniatée.

SECOND GENRE.

BARYTE.

Première espèce.

Baryte sulfatée.

Seconde espèce.

Baryte carbonatée.

T R O I S I È M E G E N R E .

S T R O N T I A N E .

Première espèce.

Strontiane sulfatée.

Seconde espèce.

Strontiane carbonatée.

Q U A T R I È M E G E N R E .

M A G N È S I E .

Première espèce.

Magnésie sulfatée.

Seconde espèce.

Magnésie boratée.

S E C O N D O R D R E .

Substances acidifères alkalines.

P R E M I E R G E N R E .

P O T A S S E .

Espèce unique.

Potasse nitratée.

S E C O N D G E N R E .

S O U D E .

Première espèce.

Soude muriatée.

Seconde espèce.

Soude boratée.

Troisième espèce.

Soude carbonatée.

T R O I S I È M E G E N R E .

A M M O N I A Q U E .

Espèce unique.

Ammoniaque muriaté.

T R O I S I È M E O R D R E .

Substances acidifères alkalino-terreuses.

G E N R E U N I Q U E .

A L U M I N E .

Première espèce.

Alumine sulfatée alkaline.

Seconde espèce.

Alumine fluatée alkaline.

S E C O N D E C L A S S E .

*Substances terreuses , dans la composition
desquelles il n'entre que des terres , unies
quelquefois avec un alkali.*

Première espèce.

Q U A R T Z .

Quartz-hyalin.

Quartz-agathe.

Quartz-résinite.

Quartz-jaspe.

Quartz-pseudomorphique.

Seconde espèce.

Zircon.

Troisième espèce.

Télésie.

	Quatrième espèce.		Dix-neuvième espèce.
Cymophane.		Actinote.	
	Cinquième espèce.		Vingtième espèce.
Spinelle.		Pyroxène.	
	Sixième espèce.		Vingt et unième espèce.
Topaze.		Staurotide.	
	Septième espèce.		Vingt-deuxième espèce.
Émeraude.		Epidote.	
	Huitième espèce.		Vingt-troisième espèce.
Euclase.		Sphène.	
	Neuvième espèce.		Vingt-quatrième espèce.
Grenat.		Wernerite.	
	Dixième espèce.		Vingt-cinquième espèce.
Amphigène.		Diallage.	
	Onzième espèce.		Vingt-sixième espèce.
Idocrase.		Anatase.	
	Douzième espèce.		Vingt-septième espèce.
Meionite.		Diopase.	
	Treizième espèce.		Vingt-huitième espèce.
Feld-spath.		Gadolinite.	
	Quatorzième espèce.		Vingt-neuvième espèce.
Corindon.		Lazulite.	
	Quinzième espèce.		Trentième espèce.
Pléonaste.		Mésotype.	
	Seizième espèce.		Trente et unième espèce.
Axinite.		Stilbite.	
	Dix-septième espèce.		Trente-deuxième espèce.
Tourmaline.		Prehnite.	
	Dix-huitième espèce.		Trente-troisième espèce.
Amphibole.		Chabasié.	

Trente-quatrième espèce.
 Analcime.
 Trente-cinquième espèce.
 Népheline.
 Trente-sixième espèce.
 Harmotome.
 Trente-septième espèce.
 Péridot.
 Trente-huitième espèce.
 Mica.
 Trente-neuvième espèce.
 Disthène.
 Quarantième espèce.
 Grammatite.
 Quarante et unième espèce.
 Pycnite.
 Quarante-deuxième espèce.
 Dipyre.
 Quarante-troisième espèce.
 Asbeste.
 Quarante-quatrième espèce.
 Talc.
 Quarante-cinquième espèce.
 Macle.

TROISIÈME CLASSE.
Substances combustibles non métalliques.

PREMIER ORDRE.
SIMPLES.
 Première espèce.
 Soufre.

Seconde espèce.
 Diamant.
 Troisième espèce.
 Anthracite.

SECOND ORDRE.
COMPOSÉES.
 Première espèce.
 Bitume.
 Seconde espèce.
 Houille.
 Troisième espèce.
 Jayet.
 Quatrième espèce.
 Succin.
 Cinquième espèce.
 Mellite.

QUATRIÈME CLASSE.
Substances métalliques.

PREMIER ORDRE.
Non oxydables immédiatement, si ce n'est à un feu très-violent, et réductibles immédiatement.

PREMIER GENRE.
PLATINE.
 Espèce unique.
 Platine natif (ferrière).

SECOND GENRE.
OR.
 Espèce unique.
 Or natif.

T R O I S I È M E G E N R E.

A R G E N T.

Première espèce.

Argent natif.

Seconde espèce.

Argent antimonial.

Troisième espèce.

Argent sulfuré.

Quatrième espèce.

Argent antimonié sulfuré.

Cinquième espèce.

Argent muriaté.

S E C O N D O R D R E.

Oxydables et réductibles immédiatement.

G E N R E U N I Q U E.

M E R C U R E.

Première espèce.

Mercure natif.

Seconde espèce.

Mercure argental.

Troisième espèce.

Mercure sulfuré.

Quatrième espèce.

Mercure muriaté.

T R O I S I È M E O R D R E.

Oxydables, mais non réductibles immédiatement.

S E N S I B L E M E N T D U C T I L E S.

P R E M I E R G E N R E.

P L O M B.

Première espèce.

Plomb natif (volcanique).

Seconde espèce.

Plomb sulfuré.

Troisième espèce.

Plomb arsenié.

Quatrième espèce.

Plomb chromaté.

Cinquième espèce.

Plomb carbonaté.

Sixième espèce.

Plomb phosphaté.

Septième espèce.

Plomb molybdaté.

Huitième espèce.

Plomb sulfaté.

S E C O N D G E N R E.

N I C K E L.

Première espèce.

Nickel arsenical.

Seconde espèce.

Nickel oxydé.

T R O I S I È M E G E N R E .

C U I V R E .

Première espèce.

Cuivre natif.

Seconde espèce.

Cuivre pyriteux.

Troisième espèce.

Cuivre gris.

Quatrième espèce.

Cuivre sulfuré.

Cinquième espèce.

Cuivre oxydé rouge.

Sixième espèce.

Cuivre muriaté.

Septième espèce.

Cuivre carbonaté bleu.

Huitième espèce.

Cuivre carbonaté vert.

Neuvième espèce.

Cuivre arseniaté.

Dixième espèce.

Cuivre sulfaté.

Q U A T R I È M E G E N R E .

F E R .

Première espèce.

Fer oxydulé.

Seconde espèce.

Fer oligiste.

Troisième espèce.

Fer arsenical.

Quatrième espèce.

Fer sulfuré.

Cinquième espèce.

Fer carburé.

Sixième espèce.

Fer oxydé.

Septième espèce.

Fer azuré.

Huitième espèce.

Fer sulfaté.

Neuvième espèce.

Fer chromaté.

C I N Q U I È M E G E N R E .

E T A I N .

Première espèce.

Etain oxydé.

Seconde espèce.

Etain sulfuré.

S I X I È M E G E N R E .

Z I N C .

Première espèce.

Zinc oxydé.

Seconde espèce.

Zinc sulfuré.

Troisième espèce.

Zinc sulfaté.

NON DUCTILES.

S E P T I È M E G E N R E.

B I S M U T H.

Première espèce.

Bismuth natif.

Seconde espèce.

Bismuth sulfuré.

Troisième espèce.

Bismuth oxydé.

H U I T I È M E G E N R E.

C O B A L T.

Première espèce.

Cobalt arsenical.

Seconde espèce.

Cobalt gris.

Troisième espèce.

Cobalt oxydé noir.

Quatrième espèce.

Cobalt arseniaté.

N E U V I È M E G E N R E.

A R S E N I C.

Première espèce.

Arsenic natif.

Seconde espèce.

Arsenic oxydé.

Troisième espèce.

Arsenic sulfuré.

1. Arsenic sulfuré rouge.

2. Arsenic sulfuré jaune.

D I X I È M E G E N R E.

M A N G A N È S E.

Espèce unique.

Manganèse oxydé.

O N Z I È M E G E N R E.

A N T I M O I N E.

Première espèce.

Antimoine natif.

Seconde espèce.

Antimoine sulfuré.

Troisième espèce.

Antimoine oxydé.

Quatrième espèce.

Antimoine hydrosulfuré.

D O U Z I È M E G E N R E.

U R A N E.

Première espèce.

Urane oxydulé.

Seconde espèce.

Urane oxydé.

T R E I Z I È M E G E N R E.

M O L Y B D È N E.

Espèce unique.

Molybdène sulfuré.

Q U A T O R Z I È M E G E N R E.

T I T A N E.

Première espèce.

Titane oxydé.

Seconde espèce.

Titane siliceo-calcaire.

QUINZIÈME GENRE.

SCHÉELIN.

Première espèce.

Schéelin ferruginé.

Seconde espèce.

Schéelin calcaire.

SEIZIÈME GENRE.

TELLURE.

Espèce unique.

Tellure natif (uni à différens métaux).

DIX-SEPTIÈME GENRE.

CHROME.

PREMIER APPENDICE.

Substances dont la nature n'est pas encore assez connue, pour permettre de leur assigner des places dans la méthode.

1. Amianthoïde.
2. Aplome.
3. Arragonite.
4. Chaux sulfatée anhydre.
5. Chaux sulfatée quartzifère.
6. Coccoïithe.
7. Diaspore.
8. Ecume de terre.
9. Emeraude de France?
10. Feld-spath apyre?

11. Jade.

12. Koupholithe.

13. Lépidolithe.

14. Madréporite.

15. Malacolithe.

16. Micarelle.

17. Petrosilex.

18. Scapolite.

19. Spath chatoyant.

20. Spath schisteux.

21. Spinthère.

22. Tourmaline apyre?

23. Triphane.

24. Zéolithe efflorescente.

25. Zéolithe radiée jaunâtre.

26. Zéolithe rouge d'Ædelfors.

SECONDE APPENDICE.

Agrégats de différentes substances minérales.

PREMIER ORDRE.

Agrégats que l'on regarde comme étant de première formation, et qui portent plus particulièrement le nom de roches.

1. Roche feld-spathique.
2. Roche quartzeuse.
3. Roche amphibolique.
4. Roche micacée.
5. Roche talqueuse.
6. Roche calcaire.
7. Roche jadienne.
8. Roche petrosiliceuse.
9. Roche cornéenne.

10. Roche

10. Roche serpentineuse.

11. Roche argileuse.

SECON D ORDRE.

Agrégats qui sont généralement regardés comme étant de seconde ou de troisième formation, et qui paroissent devoir leur naissance à des sédimens, et leur dureté au dessèchement.

I. ARGILE.

1. Argile glaise.
2. Argile smectique.
3. Argile lithomarge.
4. Argile ocreuse.
5. Argile schisteuse.

II. ARGILE CALCARIFÈRE OU MARNE.

III. CALCAIRE POLISSABLE ARGILO-FERRIFÈRE OU MARBRE SECONDAIRE.

IV. CHAUX SULFATÉE CALCARIFÈRE, vulgairement *Pierre à plâtre*.

TROISIÈME ORDRE.

Agrégats composés de fragmens ou de débris, agglutinés postérieurement à la formation des substances auxquelles ils ont appartenu.

- I. QUARTZ-AGATHE BRÈCHE.
- II. CALCAIRE BRÈCHE.
- III. QUARTZ ARÉNACÉ AGGLUTINÉ OU GRÈS.
- IV. QUARTZ ALUMINIFÈRE TRIPOLÉEN; *Tri-poli*.
- V. GRANITE RECOMPOSÉ, vulgairement *grès des houillères*.

TROISIÈME APPENDICE.

Produits des Volcans.

PREMIÈRE CLASSE.

LAVES.

Matières qui ont éprouvé la fluidité ignée.

PREMIER ORDRE.

Laves lithoïdes, c'est-à-dire, ayant l'apparence d'une pierre.

PREMIER GENRE.

LAVES LITHOÏDES BASALTIQUES.

SECOND GENRE.

LAVES LITHOÏDES PETROSILICEUSES.

TROISIÈME GENRE.

LAVES LITHOÏDES FELD-SPATHIQUES.

QUATRIÈME GENRE.

LAVES LITHOÏDES AMPHIGÉNIQUES.

SECOND ORDRE.

Laves vitreuses; ayant plus ou moins l'apparence d'une matière vitrifiée.

1. Lave vitreuse obsidienne.
2. Lave vitreuse émaillée.
3. Lave vitreuse perlée.
4. Lave vitreuse pumicée.
5. Lave vitreuse capillaire.

TROISIÈME ORDRE.

Laves scorifiées ; ayant plus ou moins de rapport , par leur aspect , avec les scories des forges.

SECONDE CLASSE.

THERMANTIDES.

Matières qui n'offrent que des indices de cuisson.

1. Thermantide cimentaire.
2. Thermantide tripoléenne.
3. Thermantide pulvérulente.

TROISIÈME CLASSE.

PRODUITS DE LA SUBLIMATION.

1. Soufre.
2. Ammoniaque muriaté.
3. Arsenic sulfuré.
4. Fer oligiste , etc.

QUATRIÈME CLASSE.

LAVES ALTÉRÉES.

Laves qui ont subi une décomposition plus ou moins avancée , par l'effet des vapeurs acido-sulfureuses , ou des vicissitudes de l'atmosphère.

Lave altérée alunifère. Pierre alumineuse de la Tolfa.

CINQUIÈME CLASSE.

TUFFS VOLCANIQUES.

Produits des éruptions boueuses , empâtemens et agglutinations par la voie humide.

SIXIÈME CLASSE.

Substances qui ont été formées dans l'intérieur des laves , postérieurement à l'époque où celles-ci ont coulé.

1. Mésotype.
2. Analcime.
3. Stilbite.
4. Chabasie.
5. Chaux carbonatée.
6. Fer sulfuré , etc.

SUBSTANCES qui ont été modifiées par la chaleur des feux souterrains non volcaniques.

1. Thermantide (non volcanique) porcellanite.
2. Thermantide (non volcanique) tripoléenne.

F I G U R E S

G É O M É T R I Q U E S .

1864

THE UNIVERSITY OF

CHICAGO

Fig. 1.

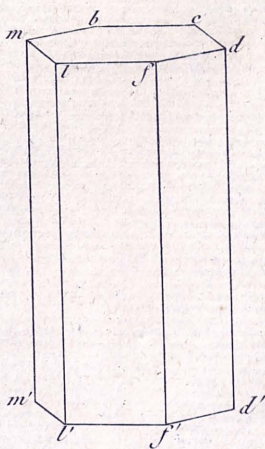

Fig. 2.

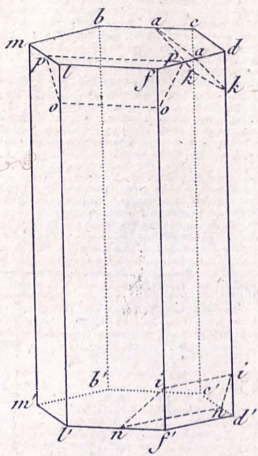

Fig. 3.

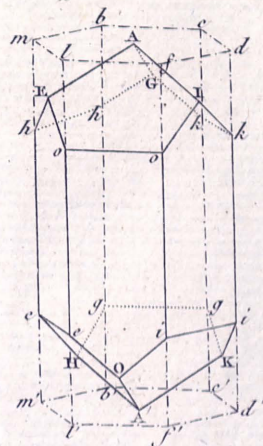

Fig. 4.

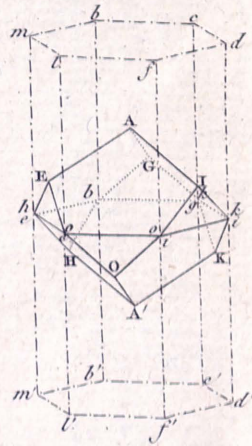

Fig. 5.

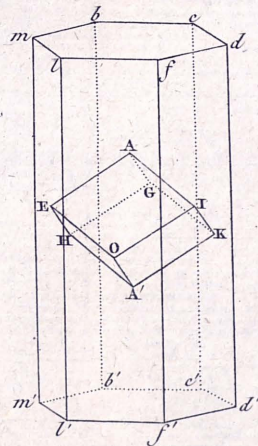

Fig. 6.

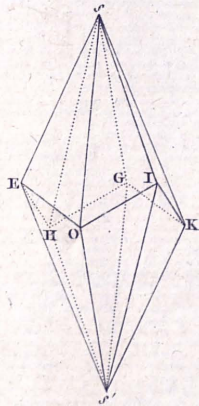

Fig. 7.

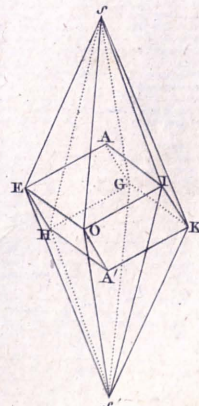
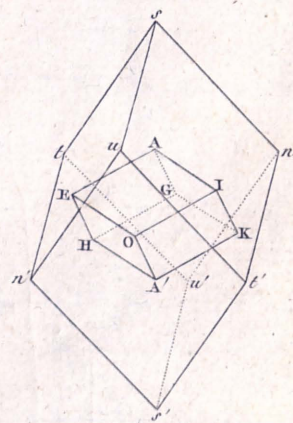

Fig. 8.



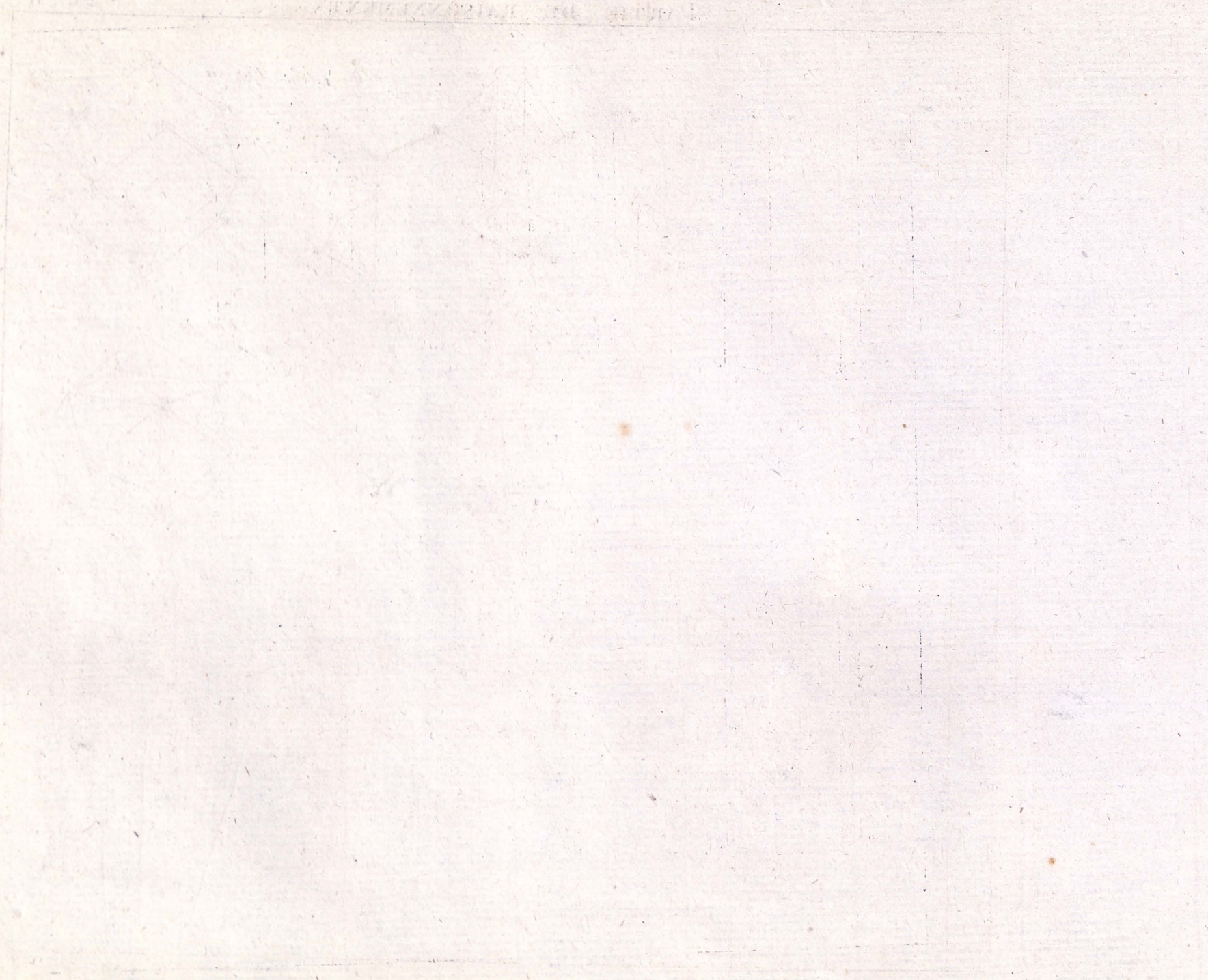

Fig. 9.

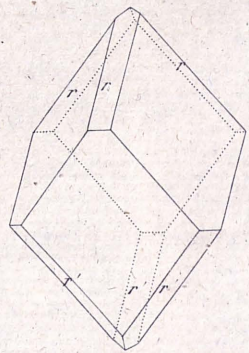

Fig. 10.

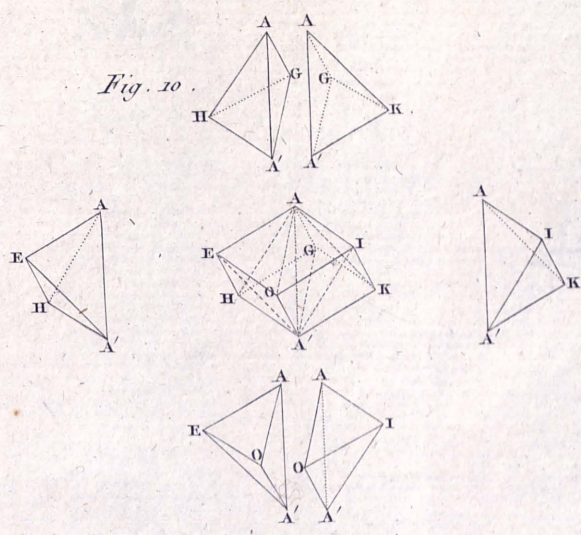

Fig. 11.

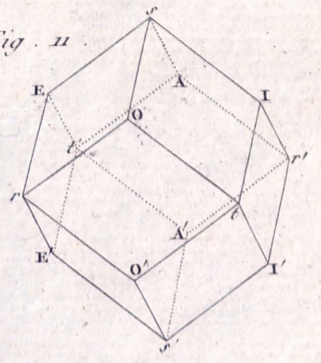

Fig. 12.

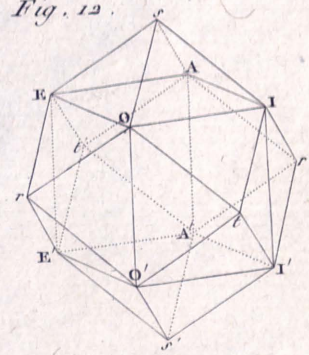

Fig. 13.

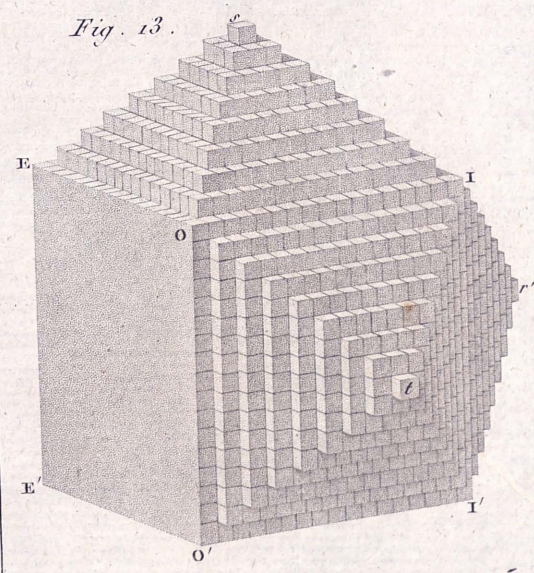

Fig. 14.

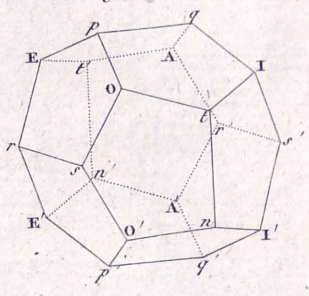

Fig. 15.

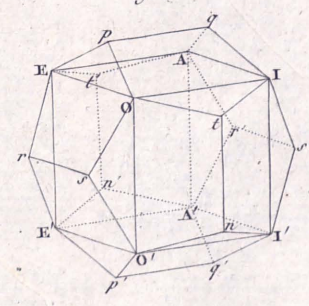
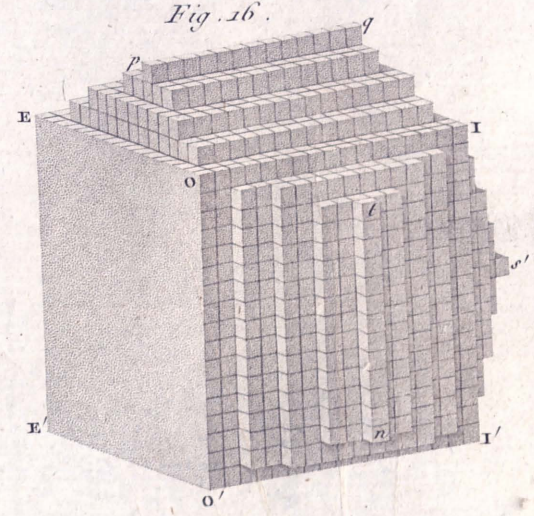
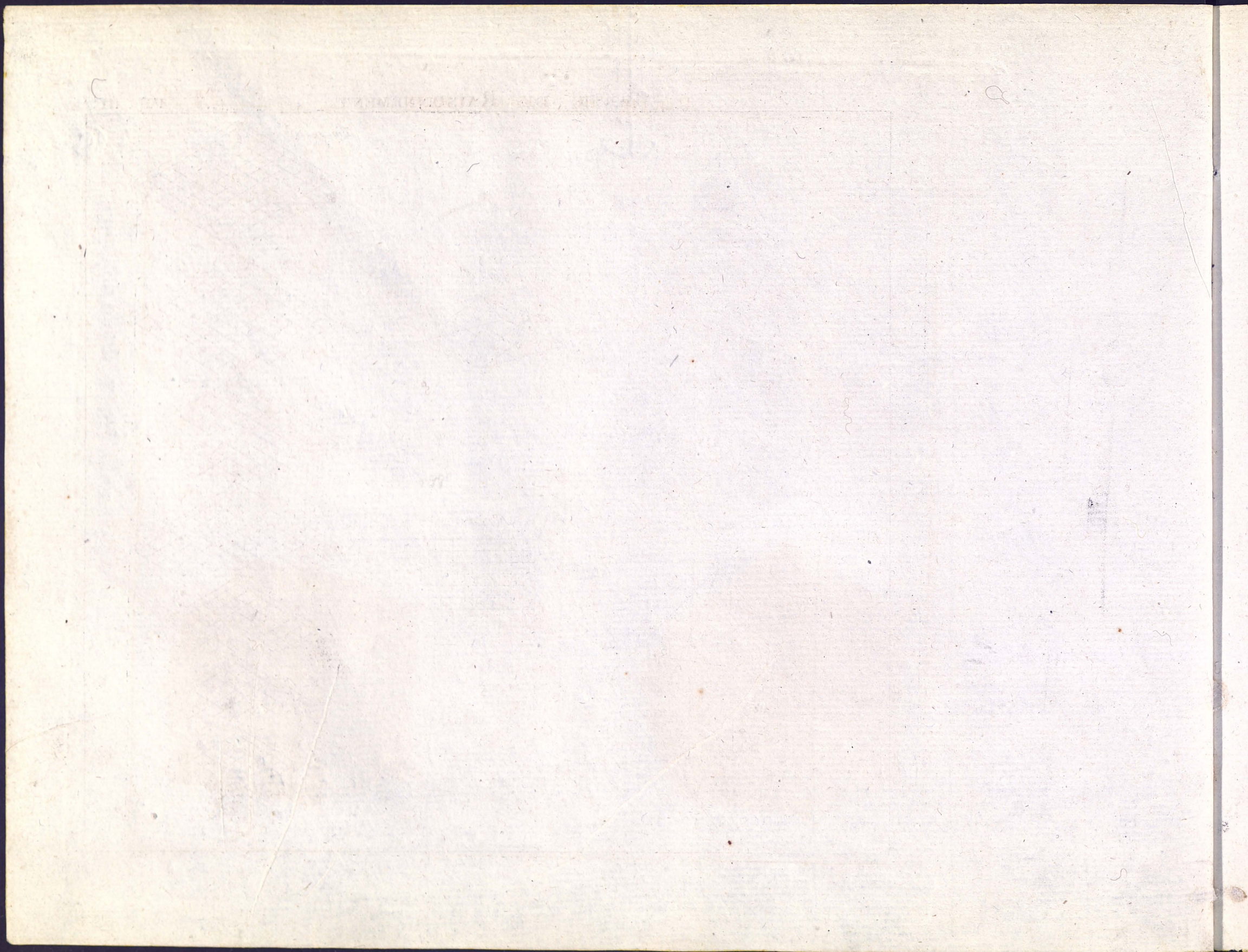

Fig. 16.





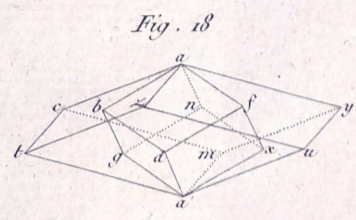
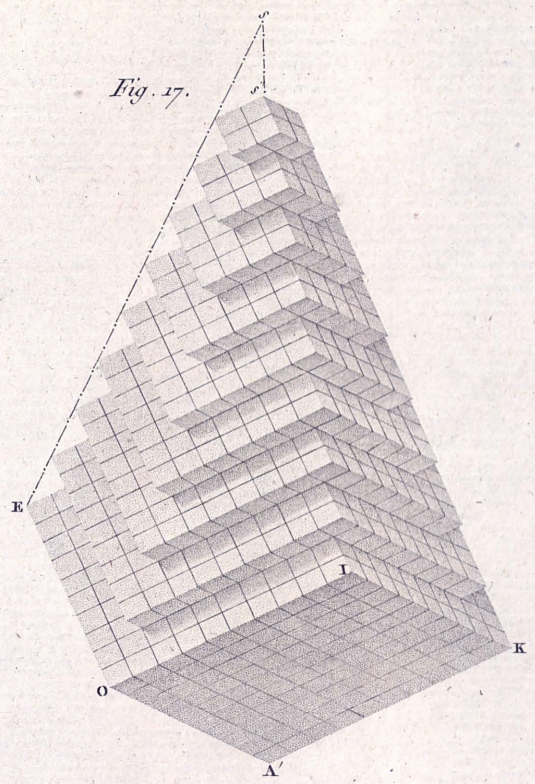
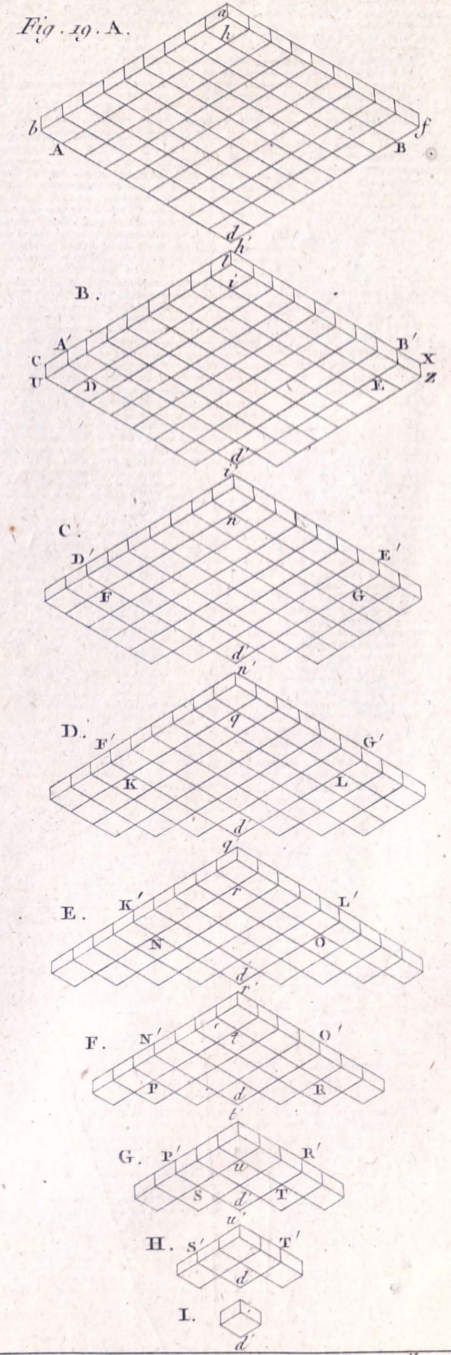
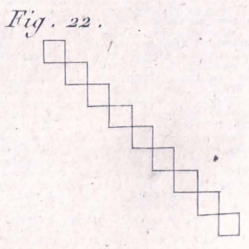
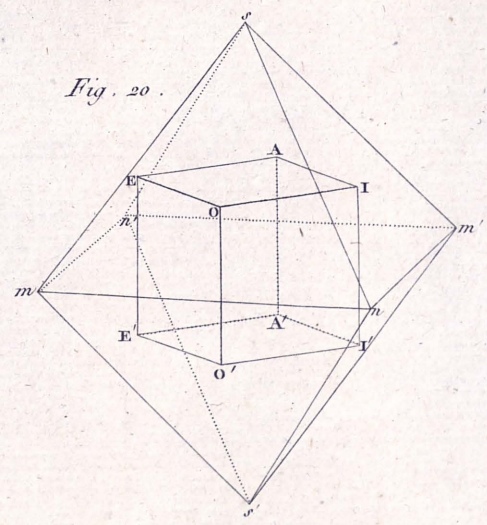

Fig. 21.

0	a								I		
	n	b									
	q	t	c								
	r	v	l	d							
	s		k	m	e						
	t			u	p	f					
	v				x	o	g				
	z					y	r	h			
0								z	s	t	I'



3

L'ART DE LA PLOMBERIE

PLATEAU

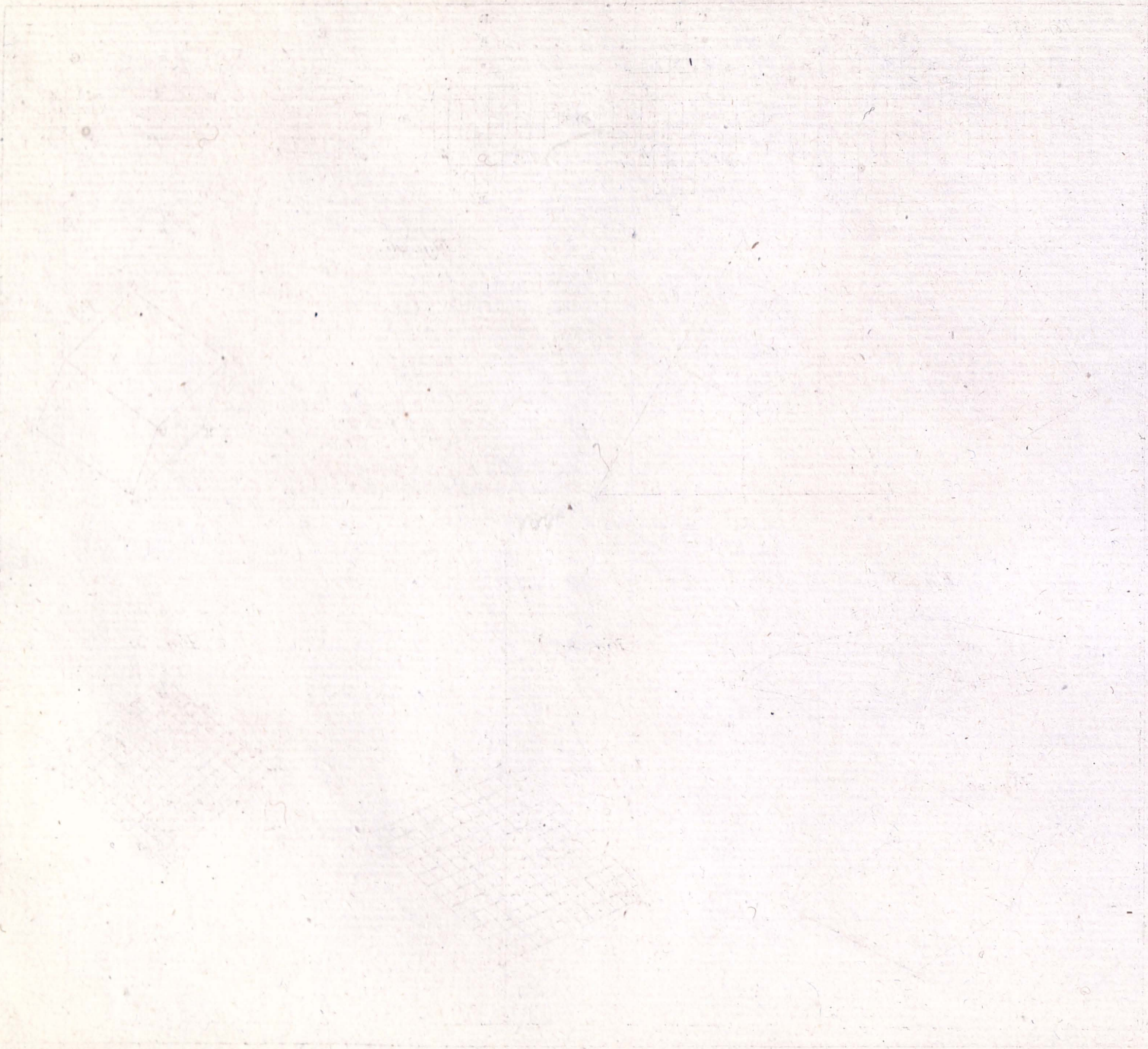

6

3

Fig. 23. A

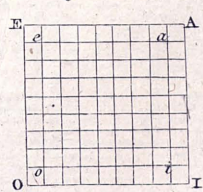

B

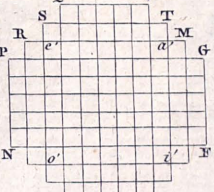

C

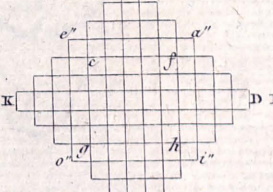

D

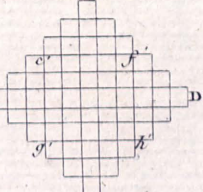

E

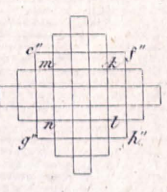

F

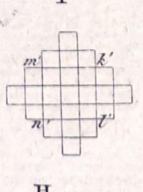

G

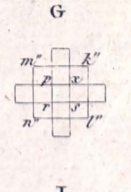

Fig. 24.

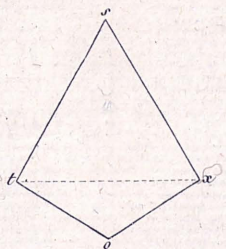

Fig. 25.

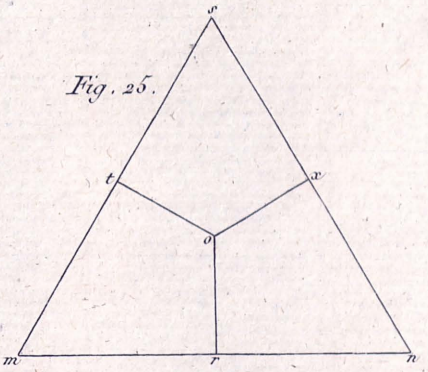

Fig. 26.

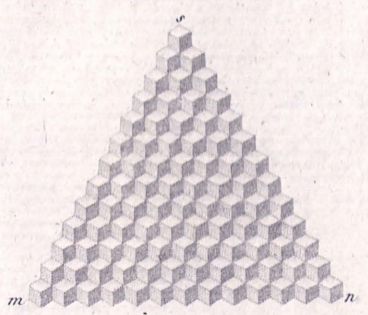

Fig. 27.

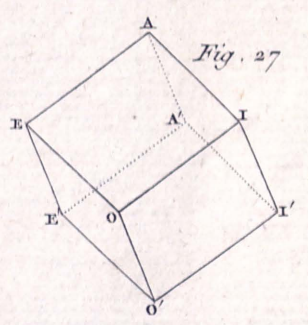

Fig. 28.

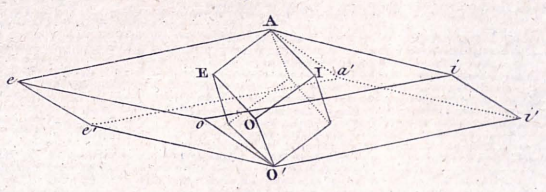

Fig. 29.

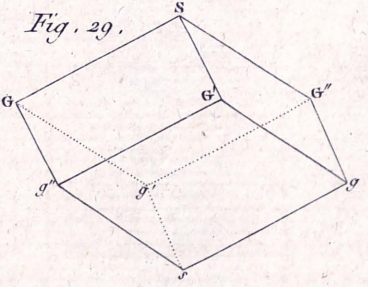

Fig. 30.

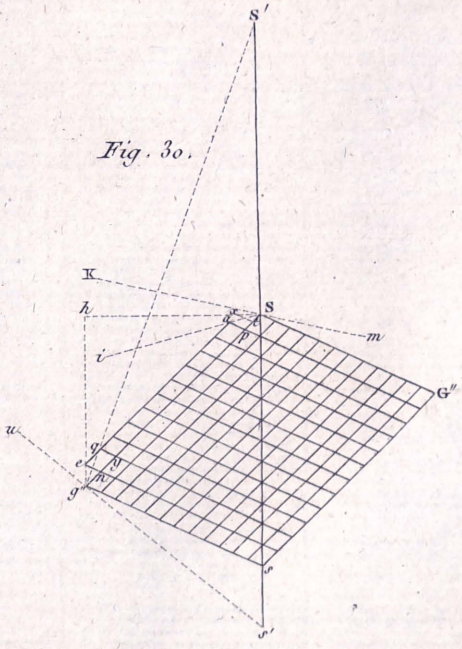
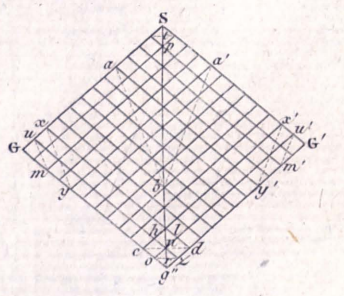

Fig. 31.



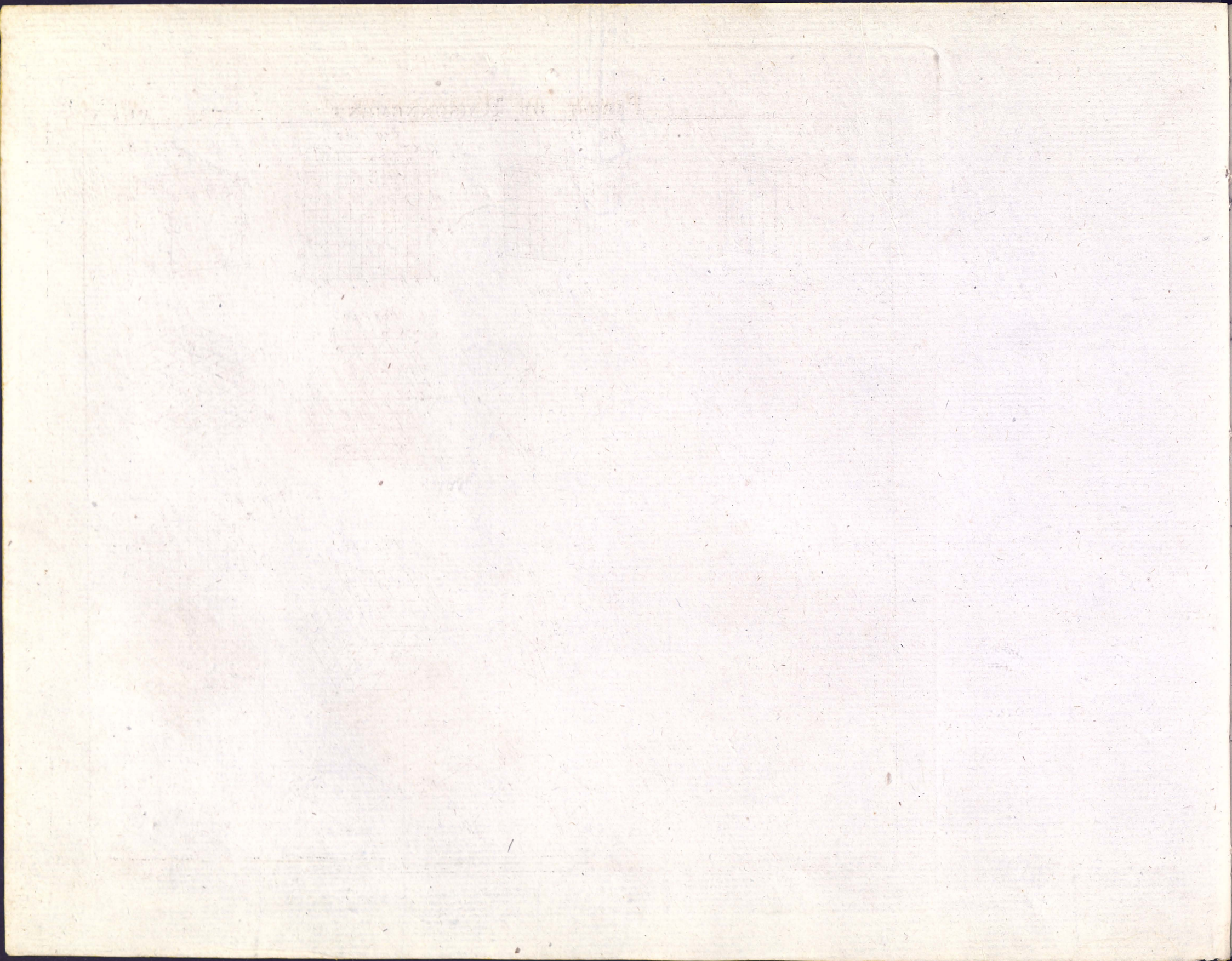

Fig. 32.

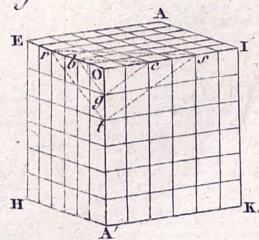

Fig. 33.

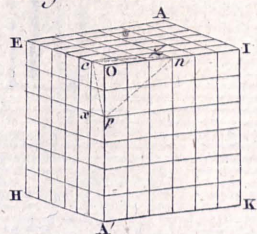

Fig. 34.

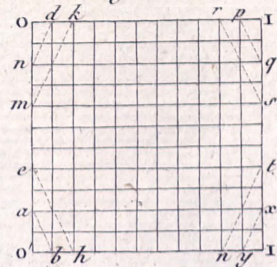

Fig. 35.

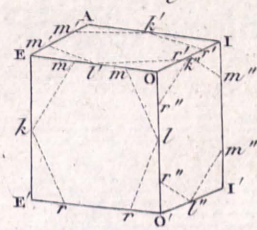

Fig. 36.

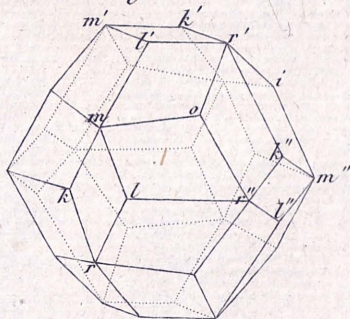

Fig. 38.

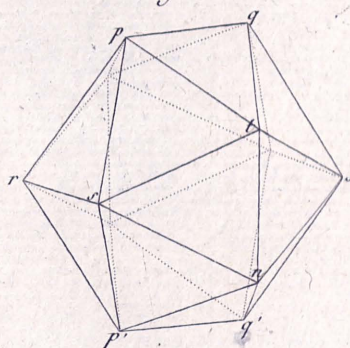

Fig. 40.

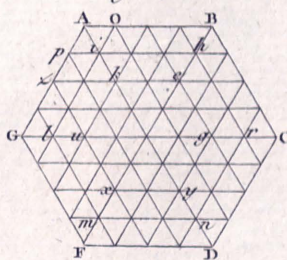

Fig. 42.

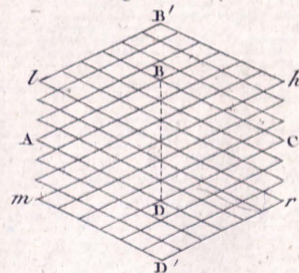

Fig. 37.

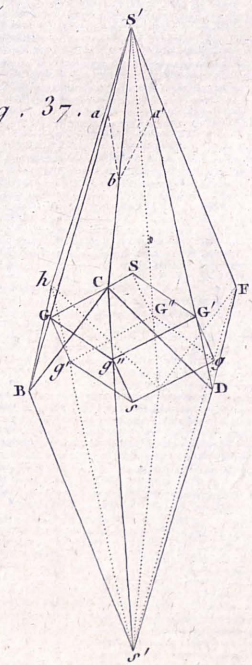

Fig. 39.

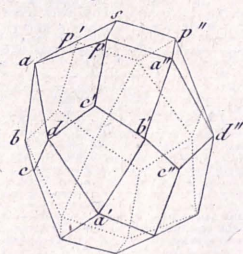

Fig. 41.

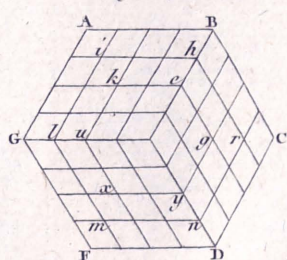

Fig. 43.

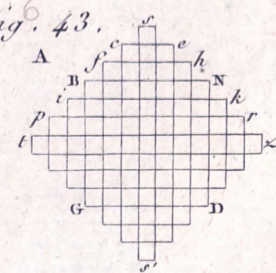

Fig. 39.A

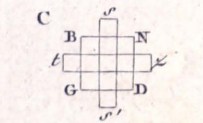
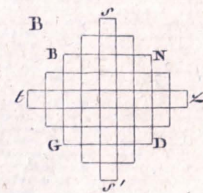
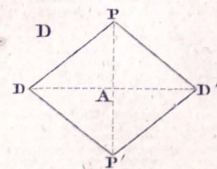
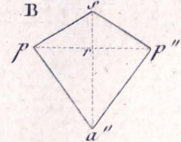
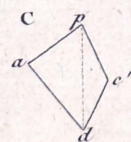
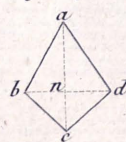
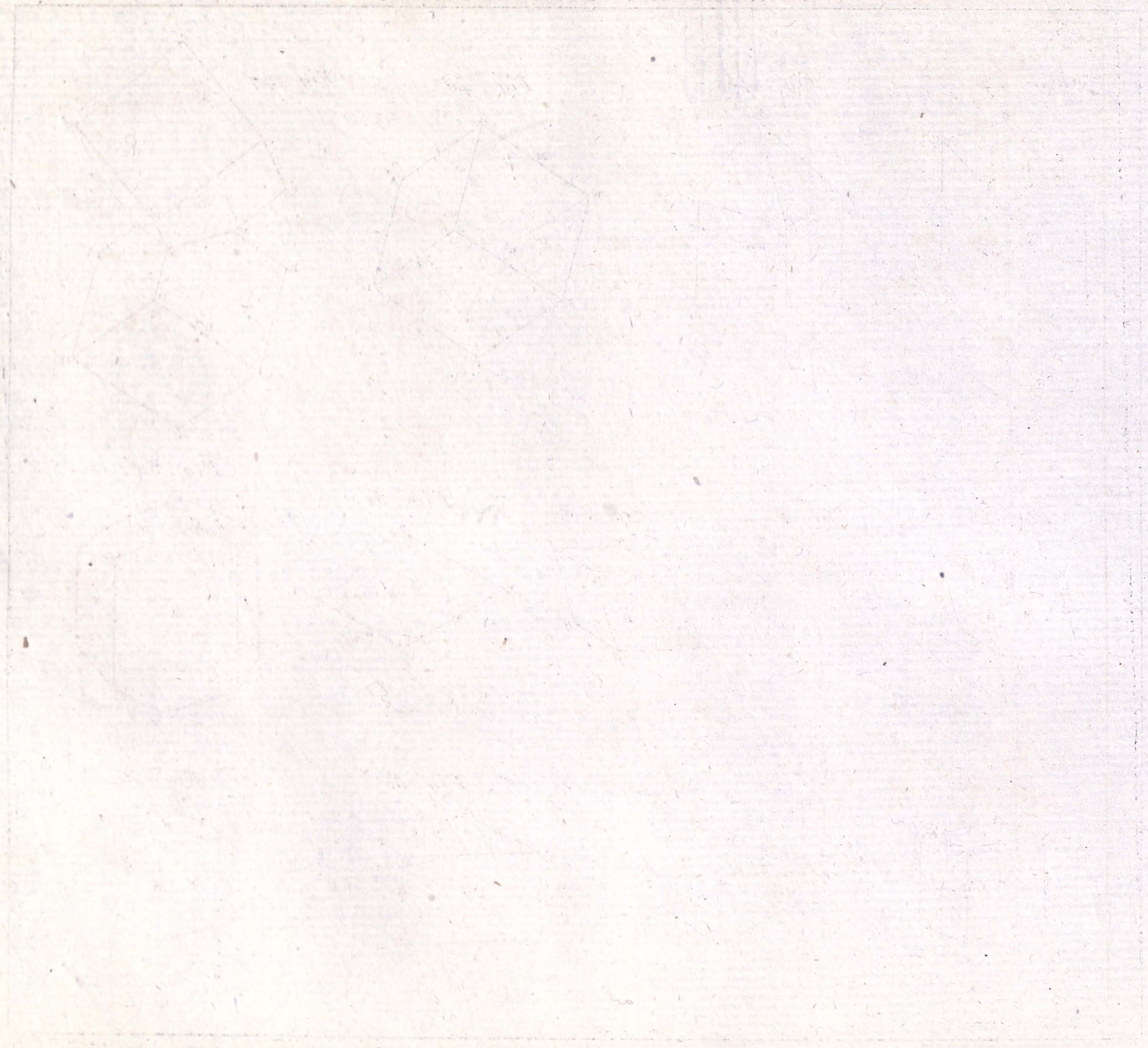

PLATE I

THE PRINCIPLES OF GEOMETRY



5

Fig. 44

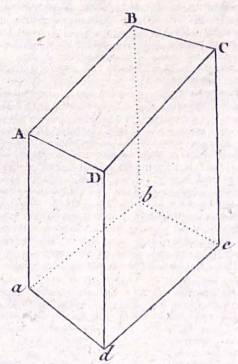

Fig. 45

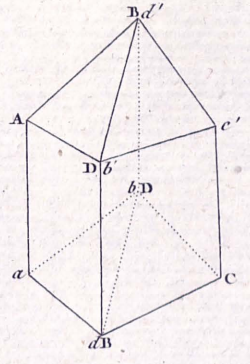

Fig. 46

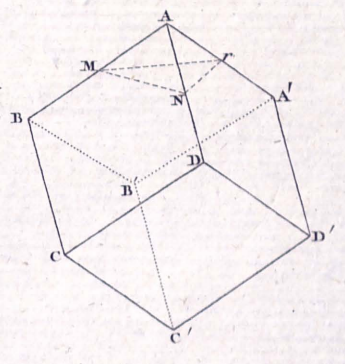

Fig. 47

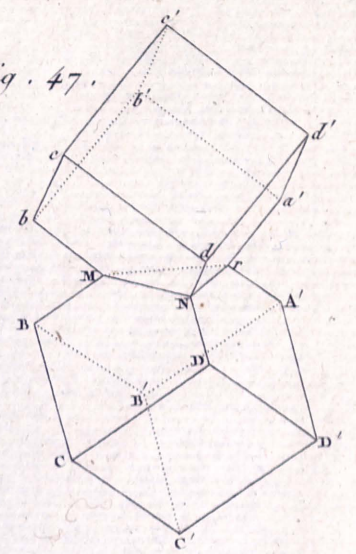

Fig. 48

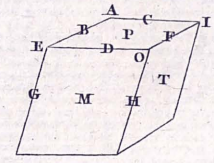

Fig. 49

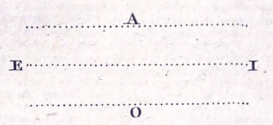

Fig. 50

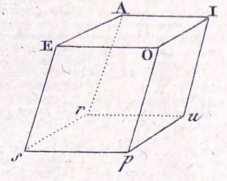

Fig. 51

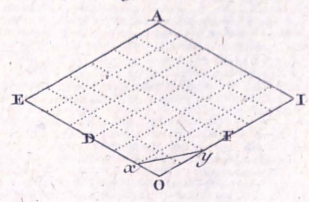

Fig. 52

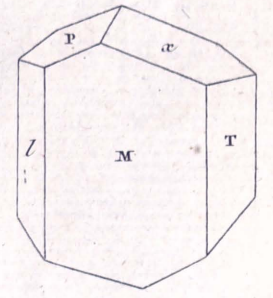

Fig. 53

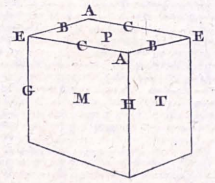

Fig. 54

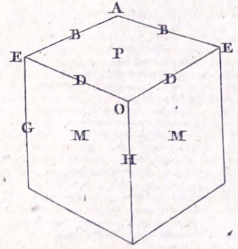

Fig. 55

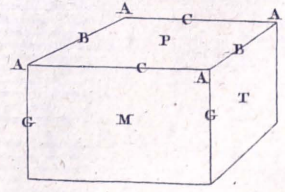
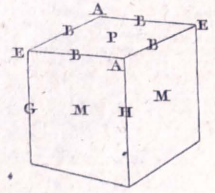
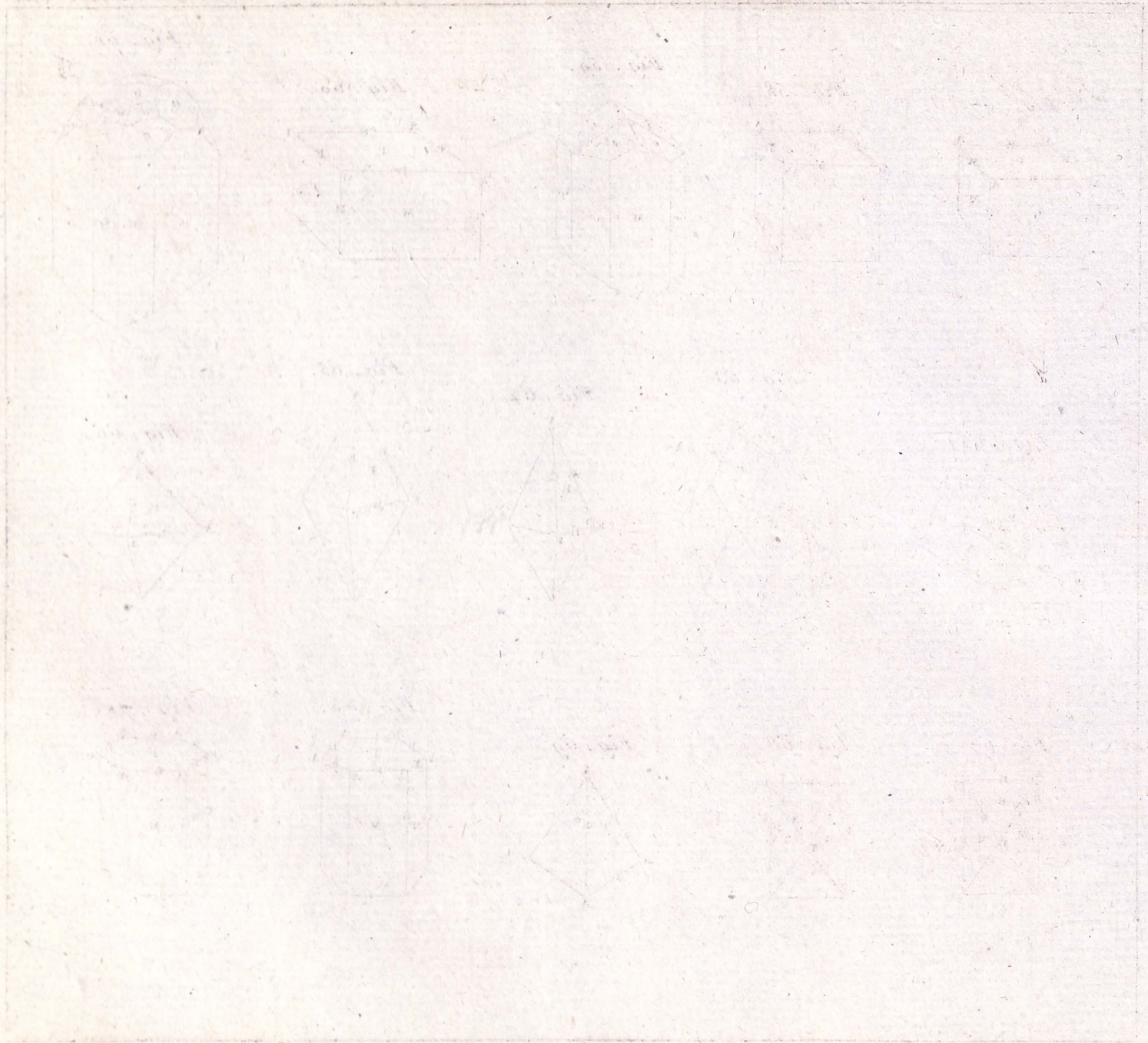
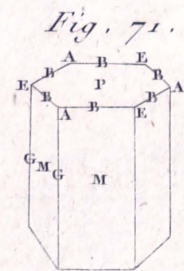
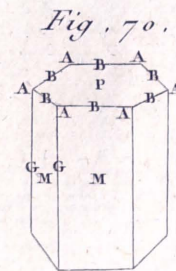
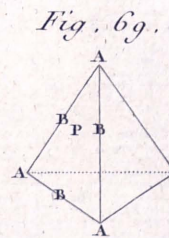
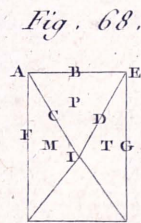
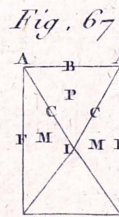
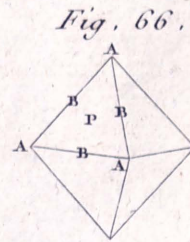
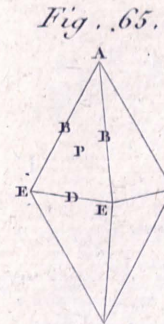
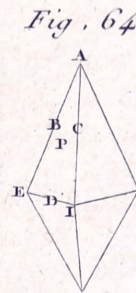
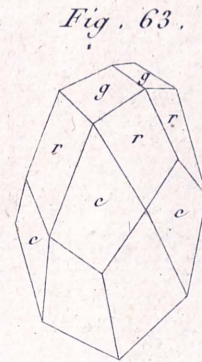
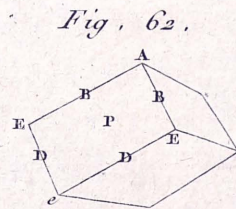
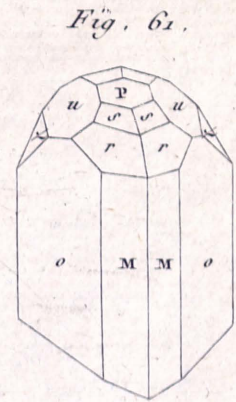
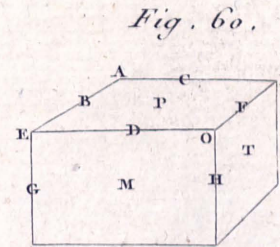
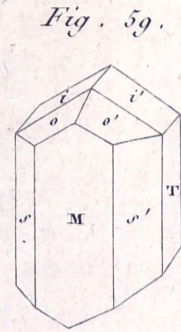
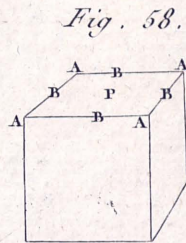
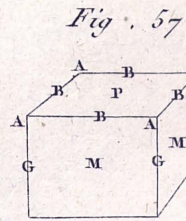

Fig. 56









3

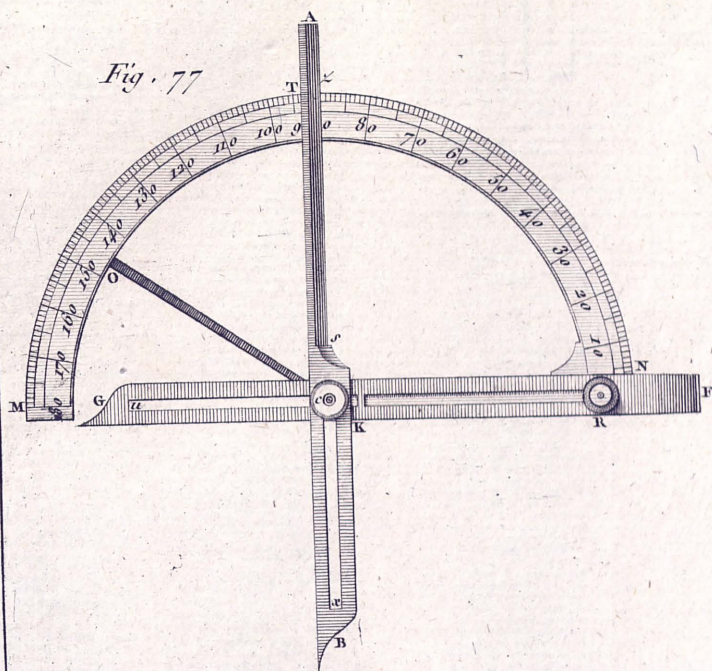

Fig. 77

Fig. 73.

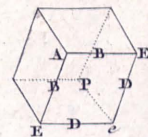

Fig. 74.

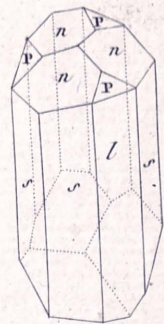

Fig. 75.



Fig. 72.

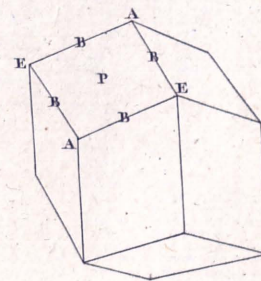
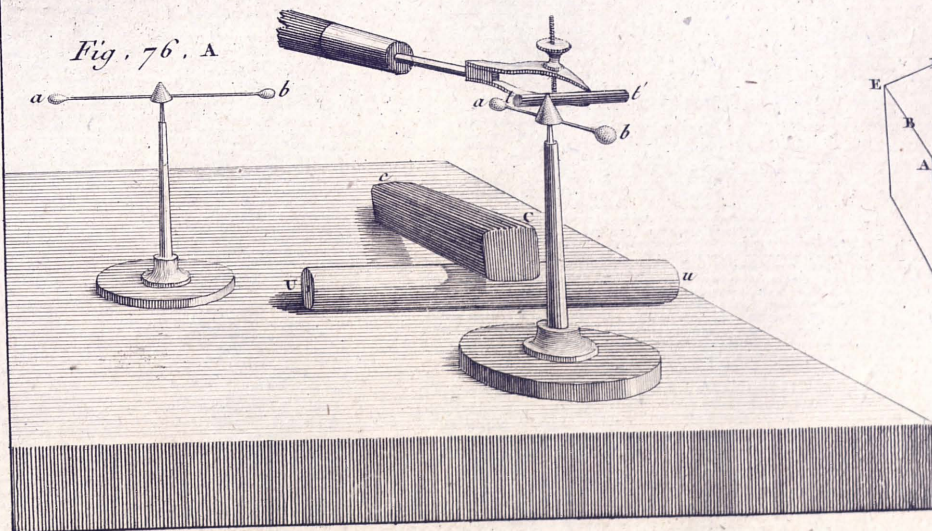
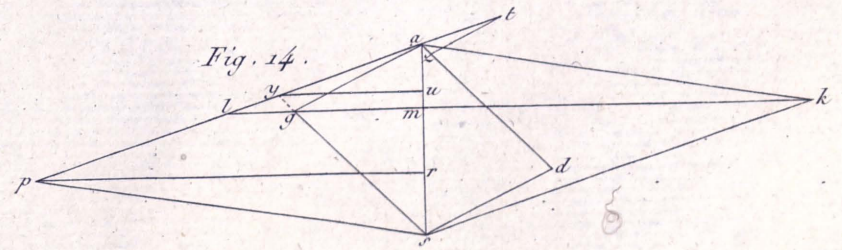
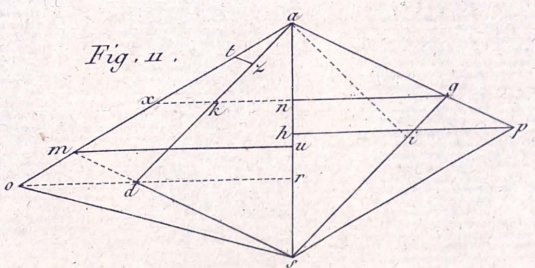
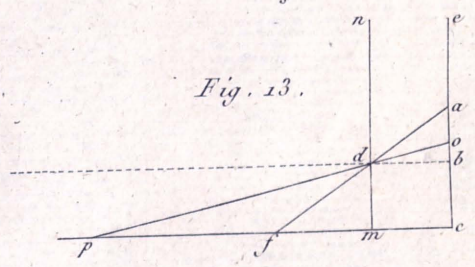
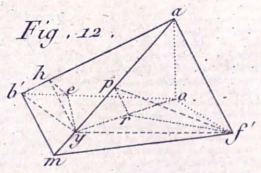
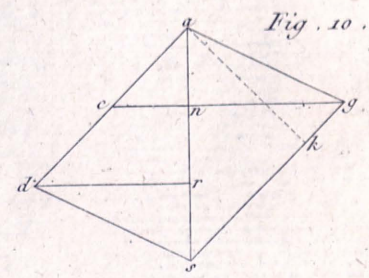
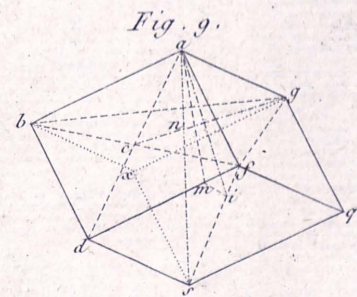
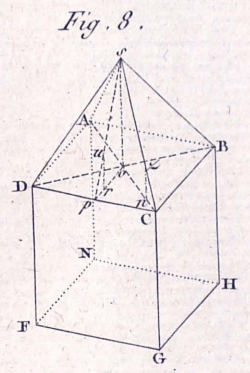
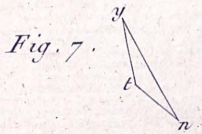
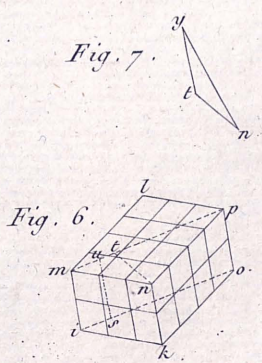
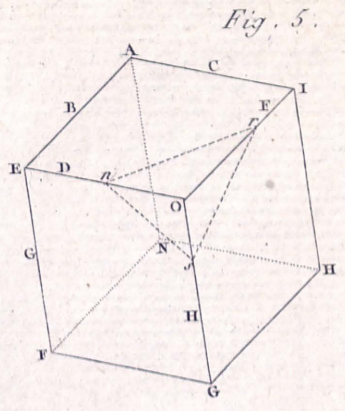
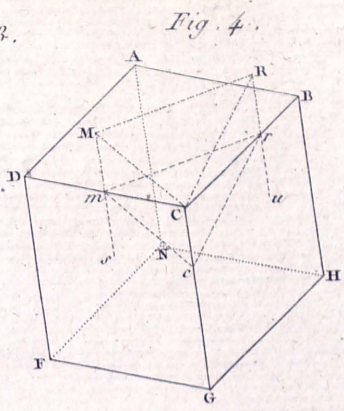
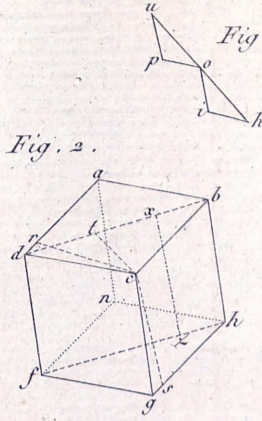
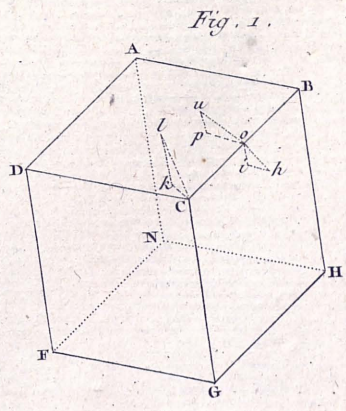

Fig. 76. B

Fig. 76. A







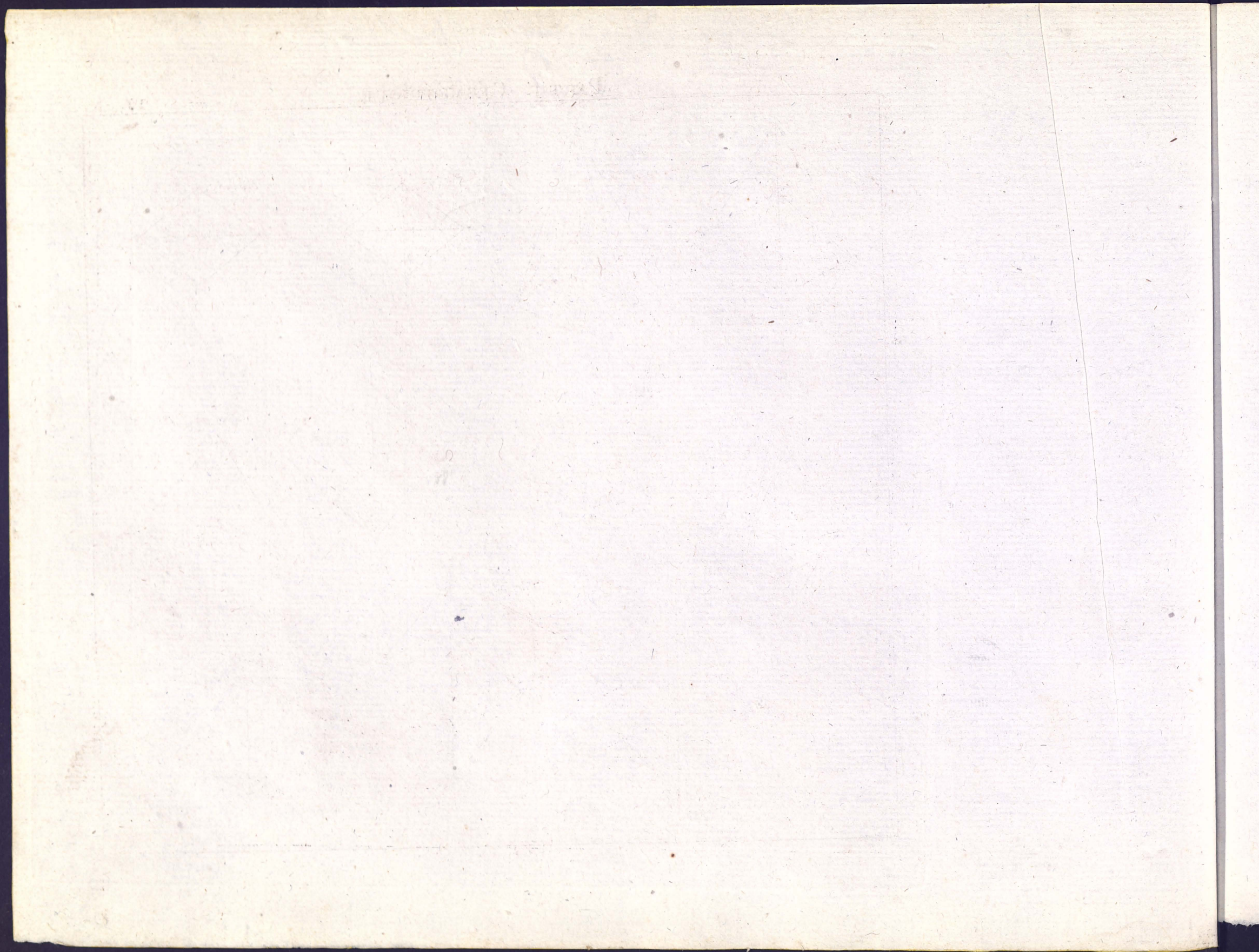

Fig. 15.

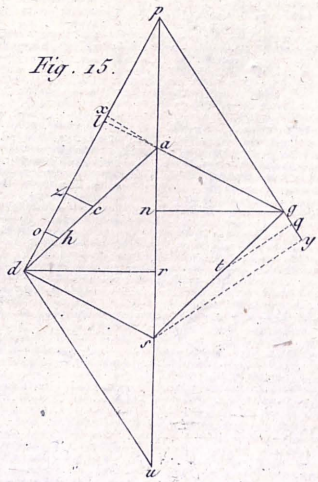

Fig. 16.

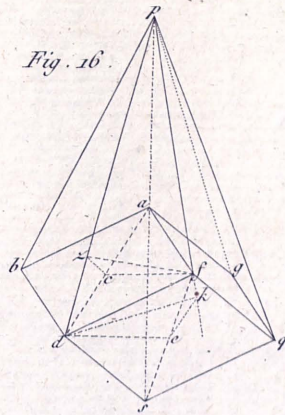

Fig. 17.

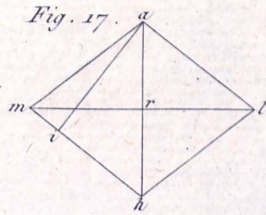

Fig. 18.

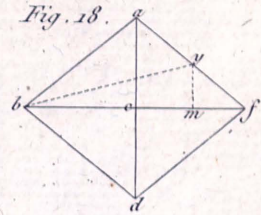

Fig. 19.

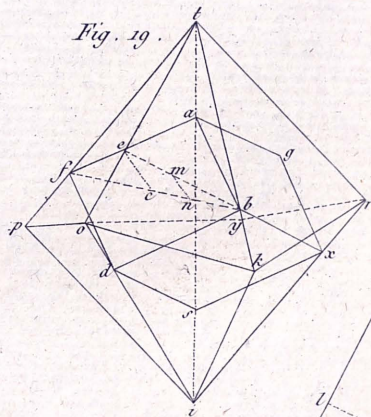

Fig. 20.

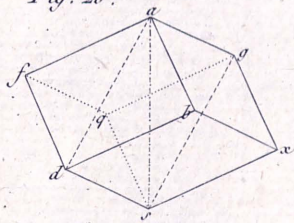

Fig. 21.

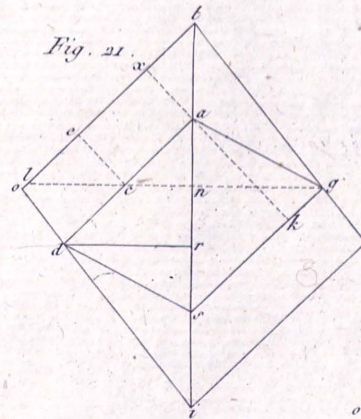

Fig. 22.

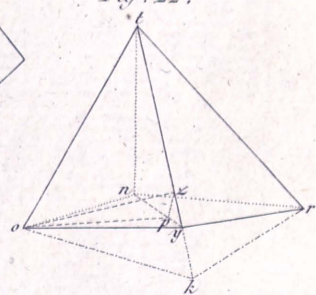

Fig. 23.

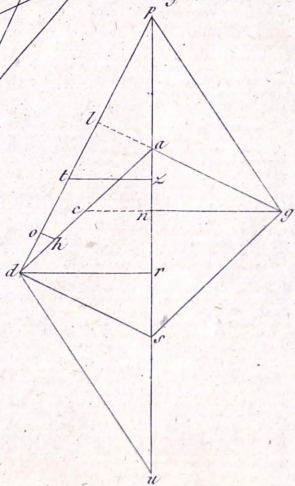

Fig. 24.

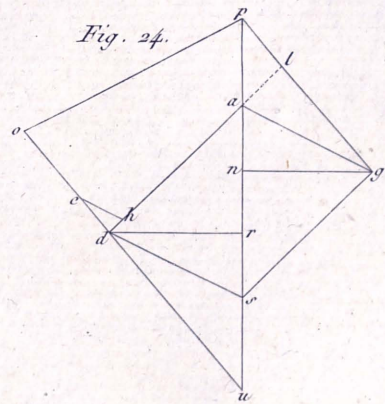
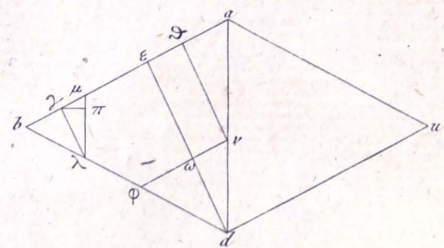
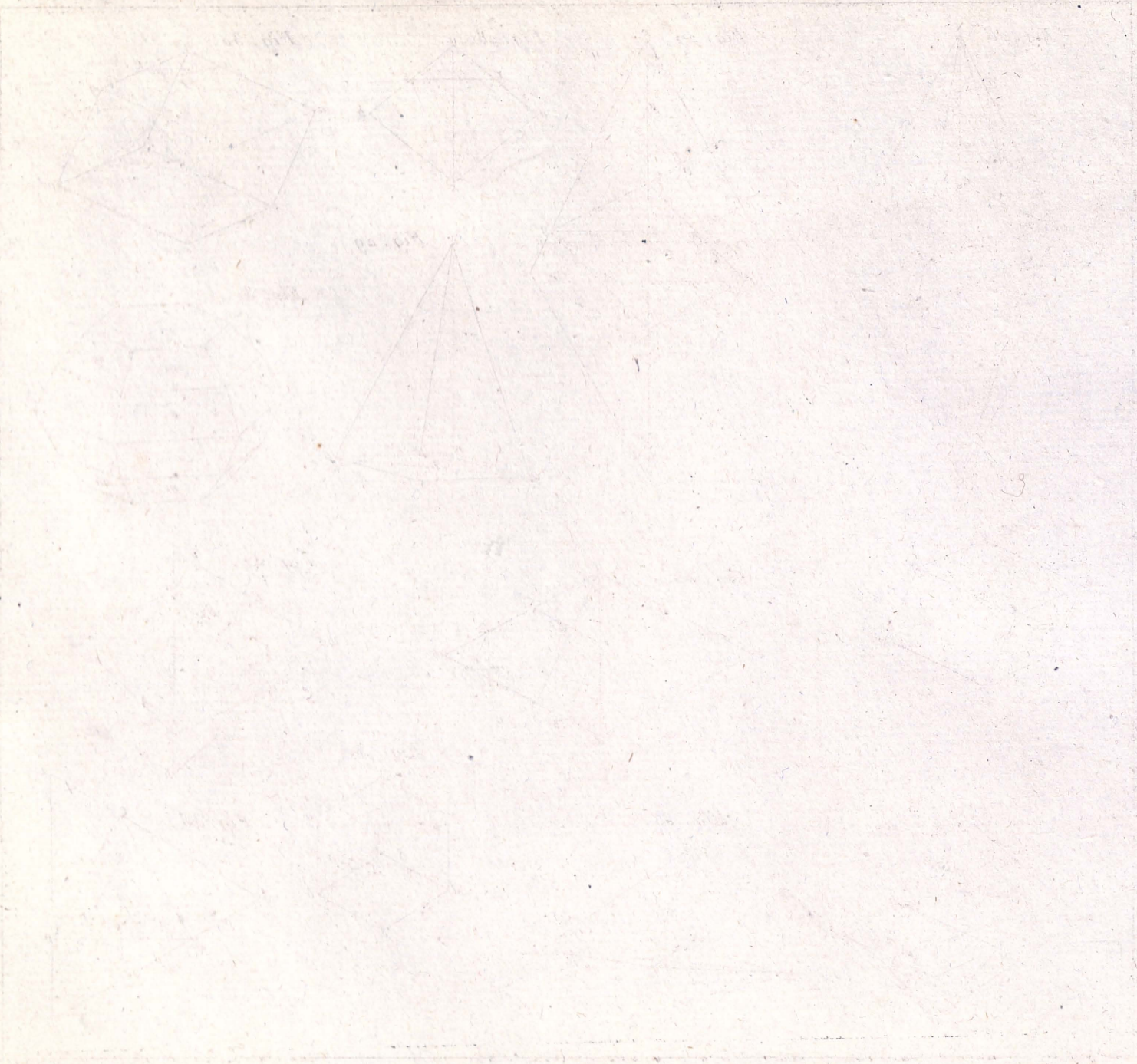
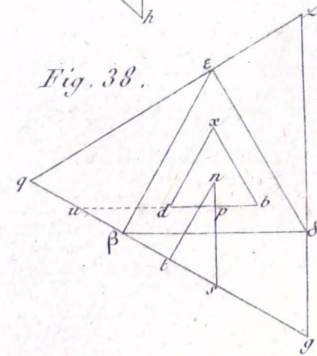
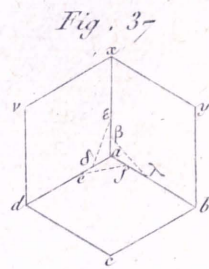
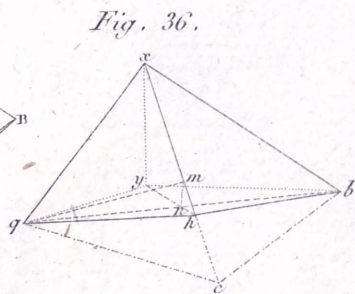
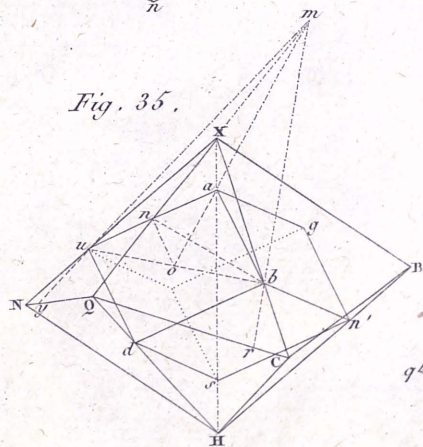
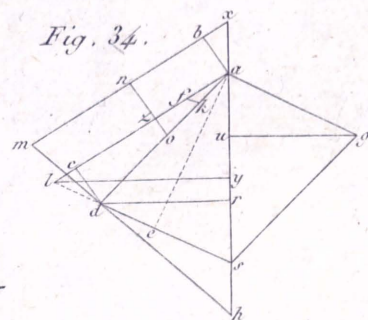
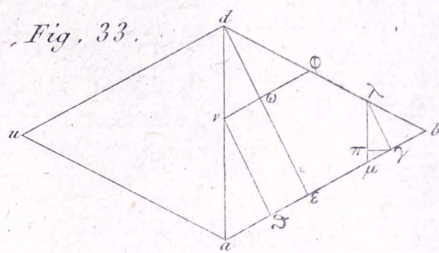
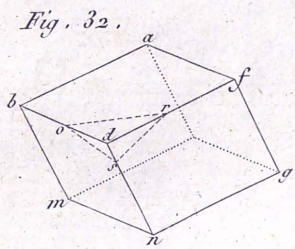
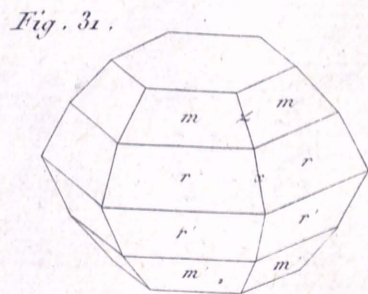
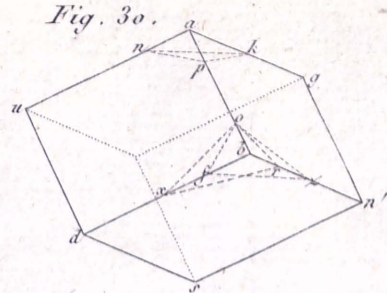
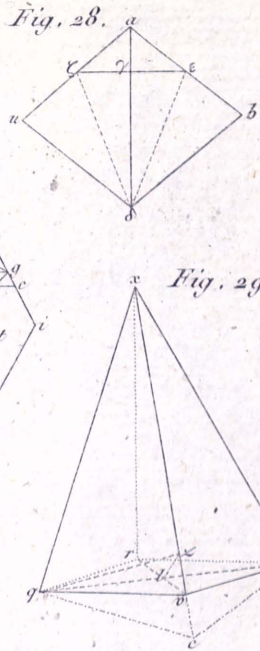
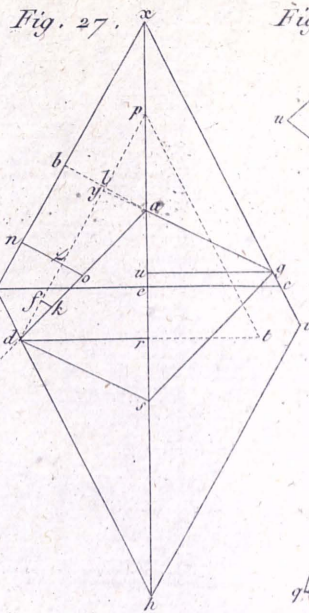
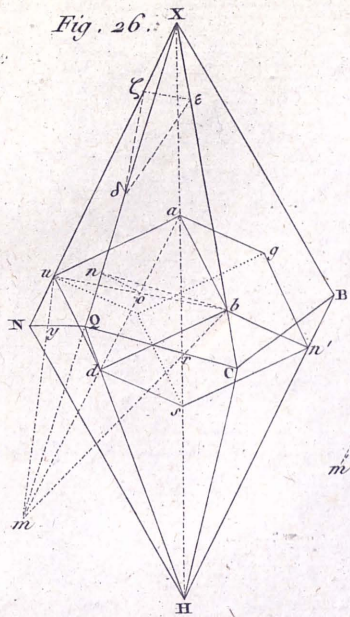

Fig. 25.









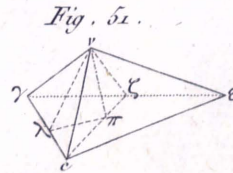
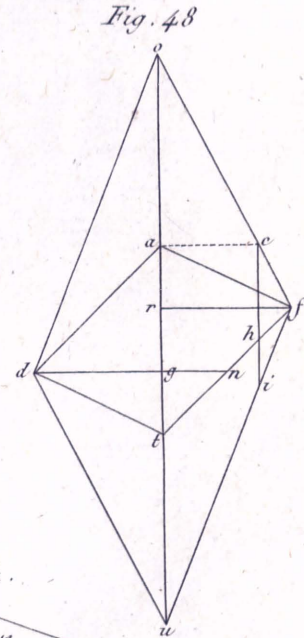
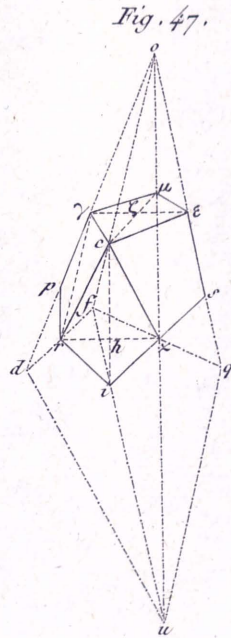
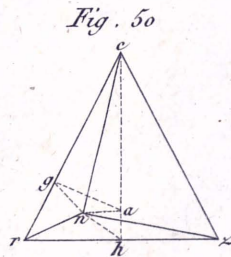
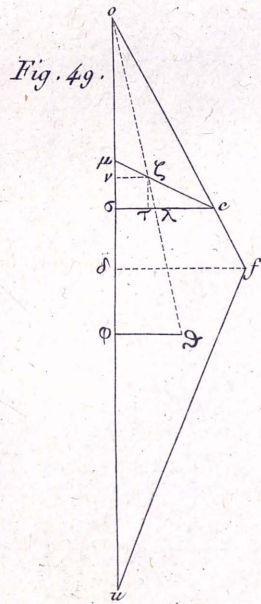
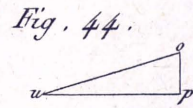
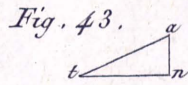
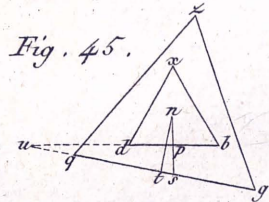
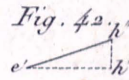
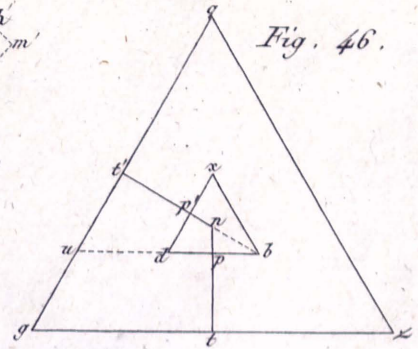
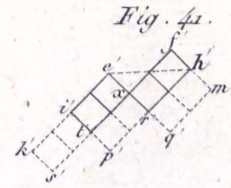
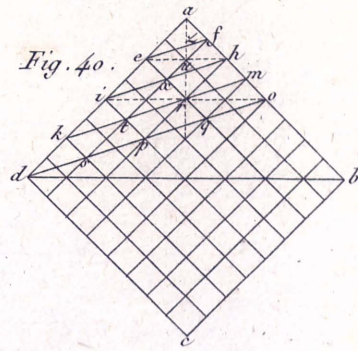
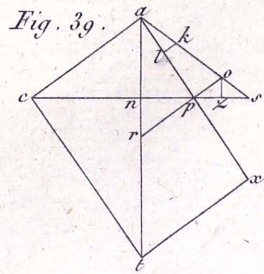

PLATE I

THE GEOMETRY OF THE



Fig. 52.

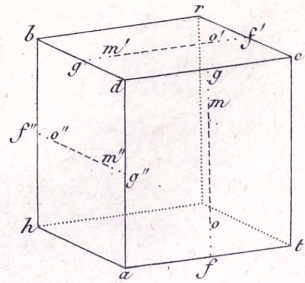

Fig. 53.

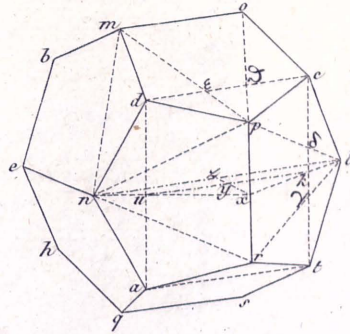

Fig. 54.

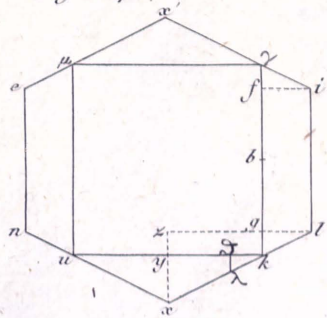

Fig. 55.

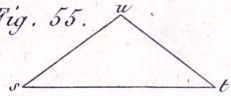

Fig. 56.

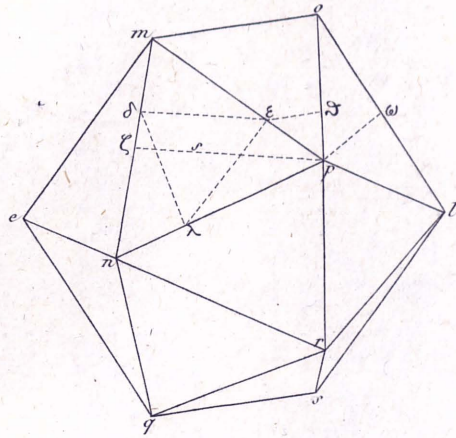

Fig. 58.

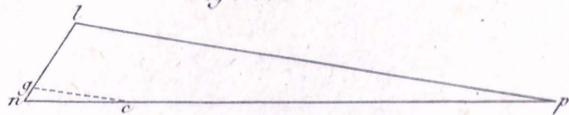

Fig. 57.

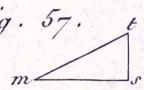

Fig. 59.

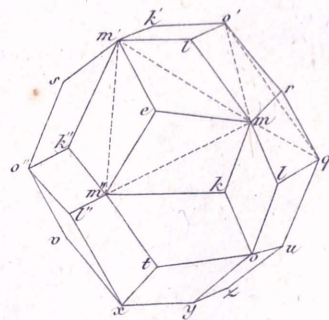

Fig. 60.

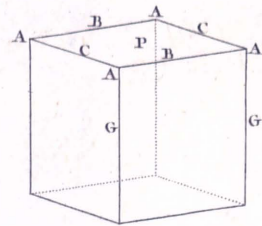

Fig. 61.

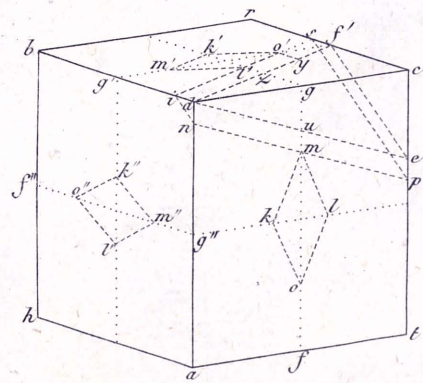

Fig. 62.

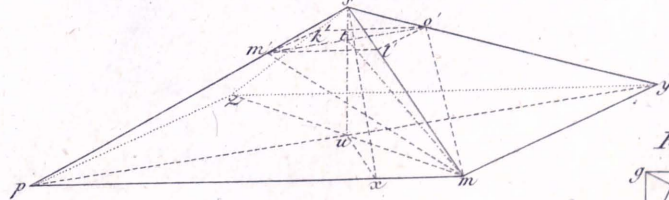

Fig. 63.

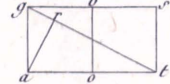
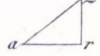
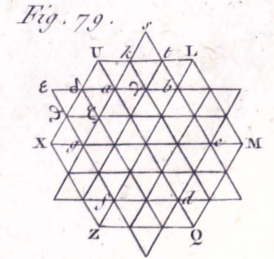
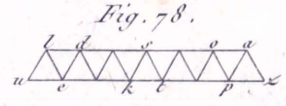
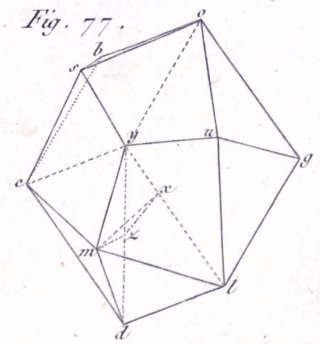
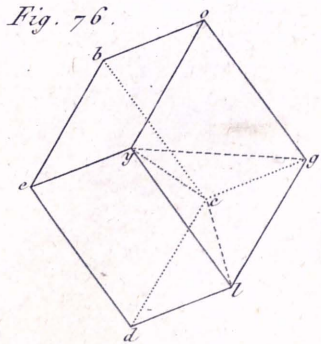
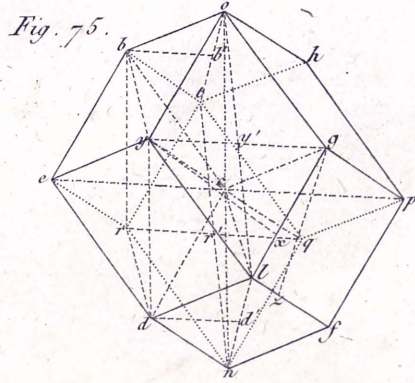
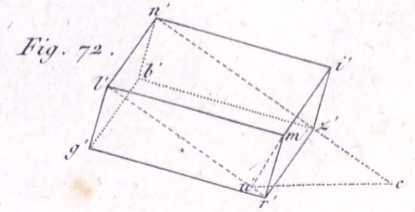
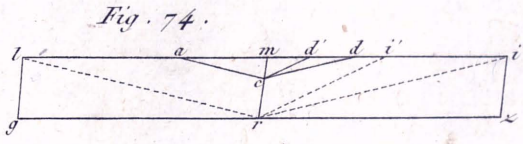
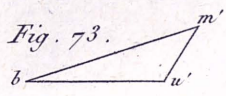
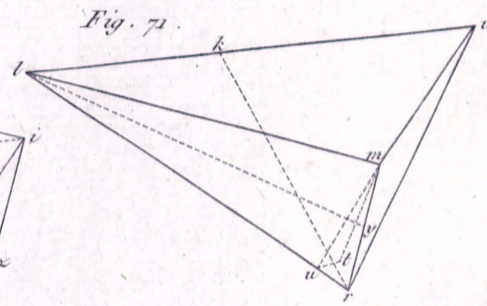
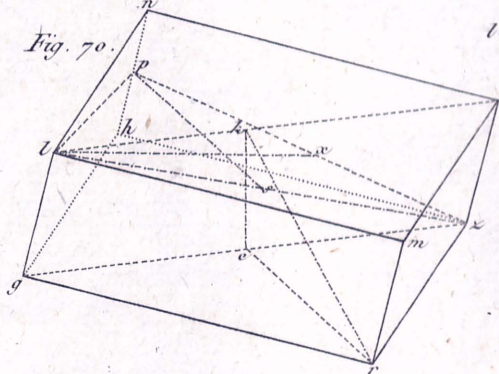
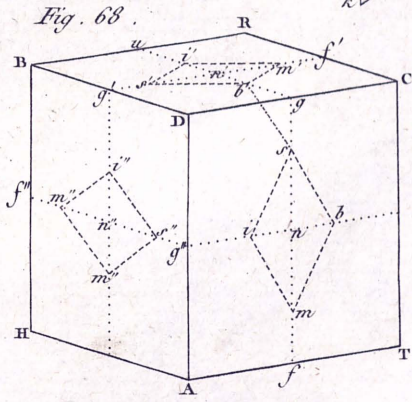
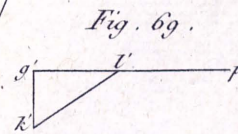
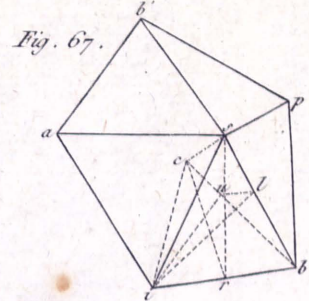
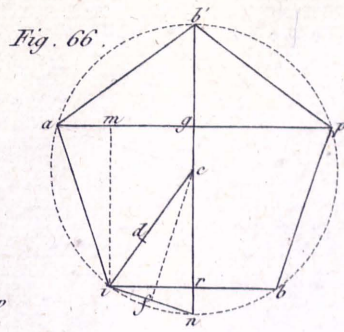
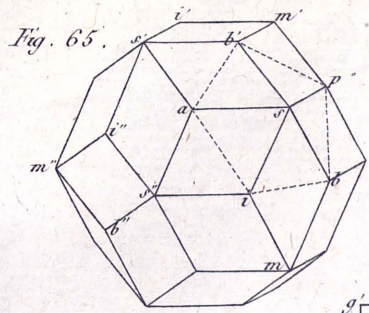

Fig. 64.



1774
L'ART DE LA PERSPECTIVE
PLANCHE I





1870

17

1870

1870



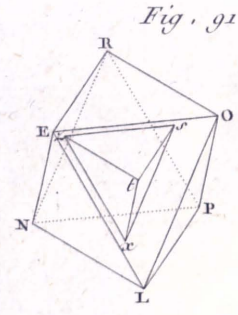
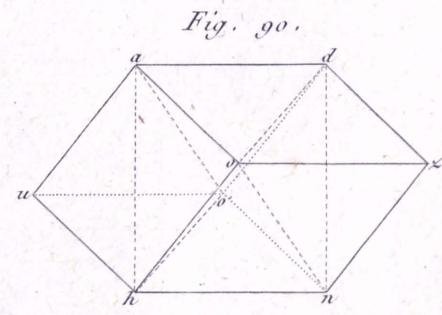
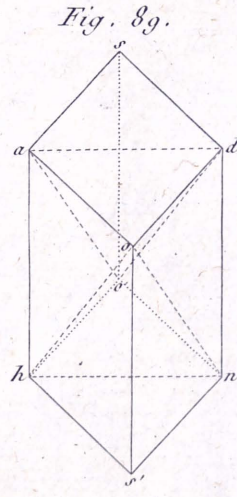
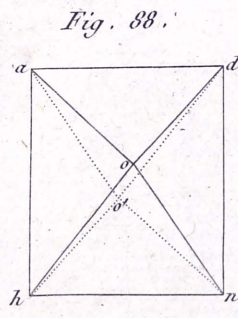
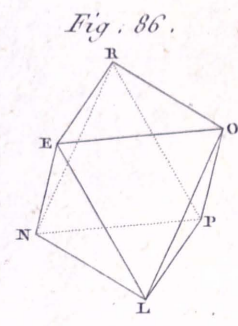
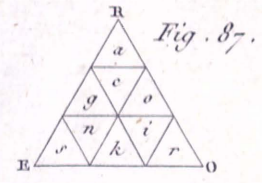
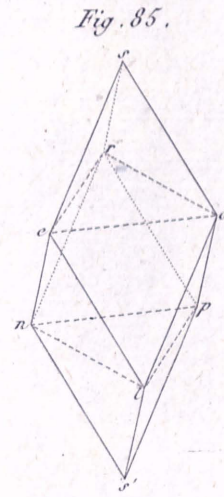
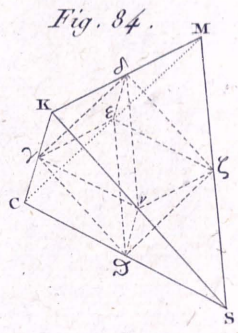
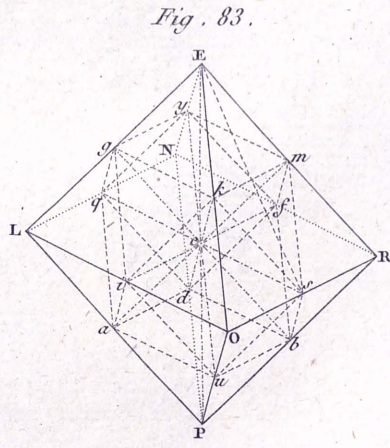
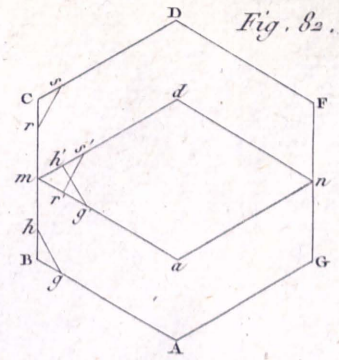
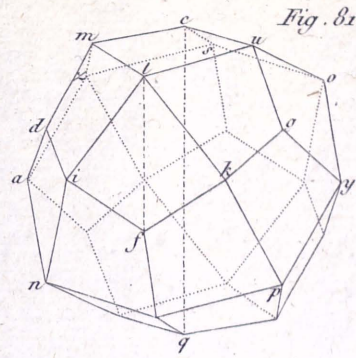
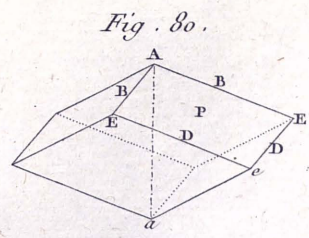



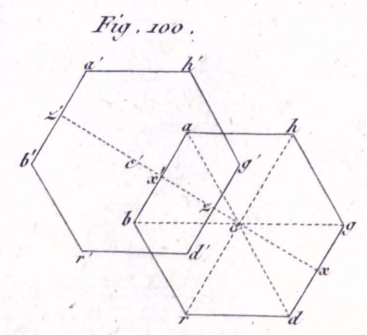
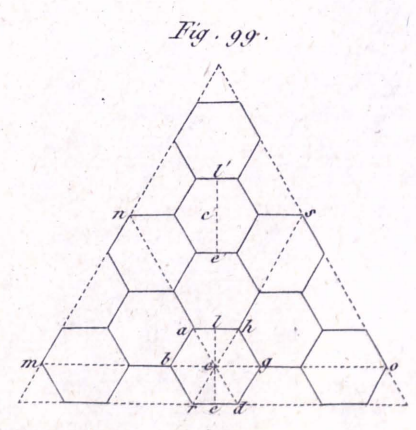
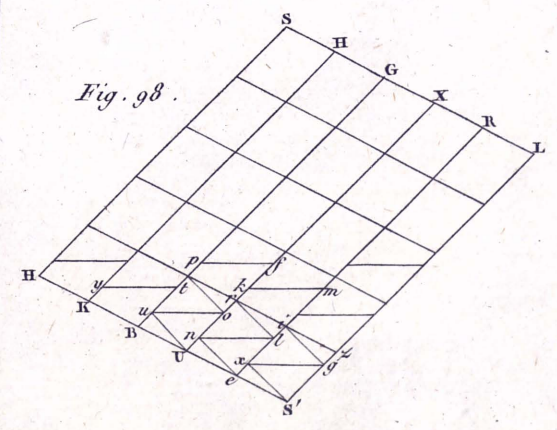
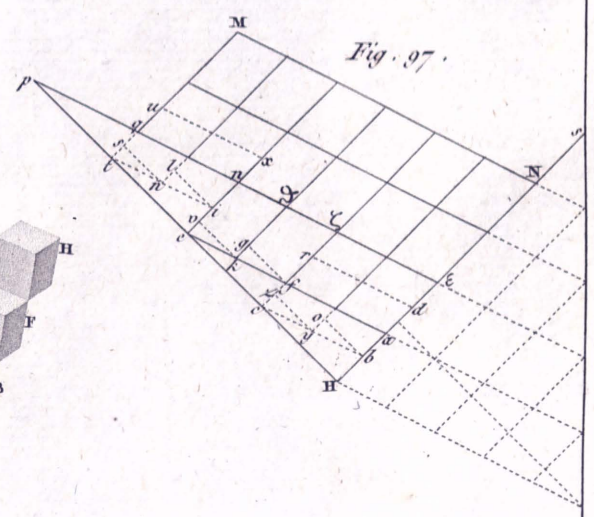
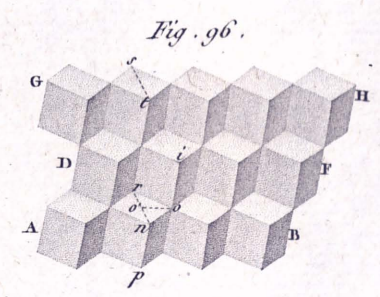
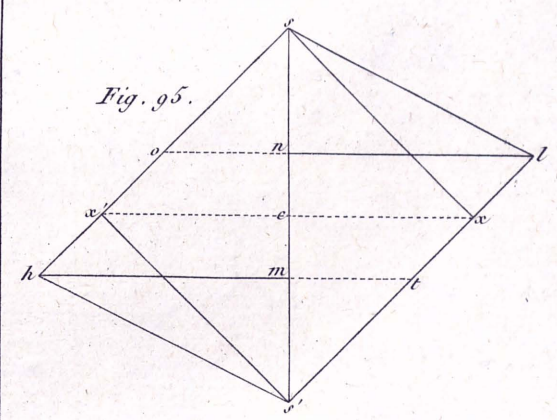
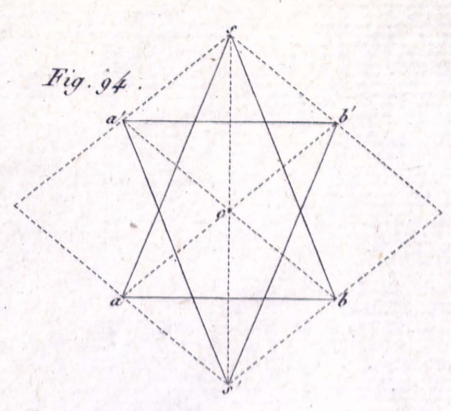
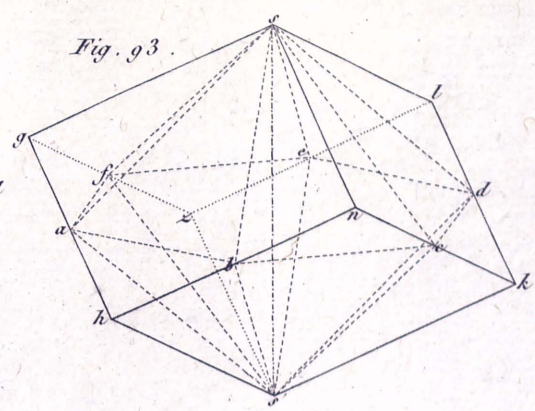
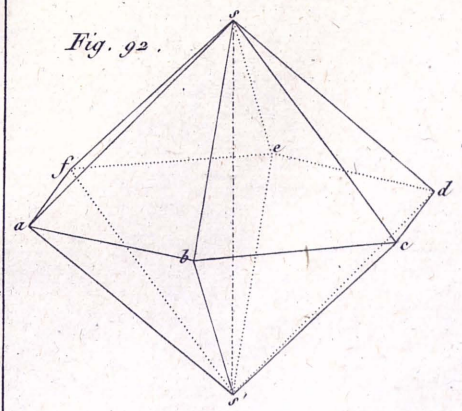

PLATE I



Fig. 101.

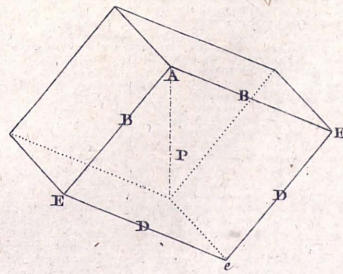

Fig. 102.

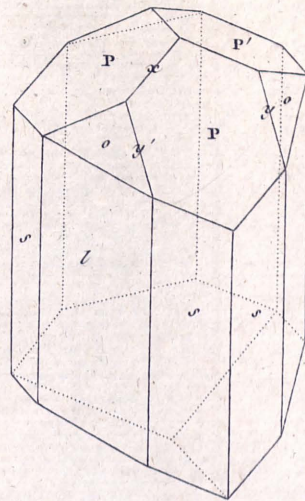

Fig. 103.

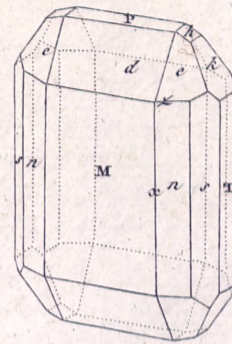

Fig. 104.

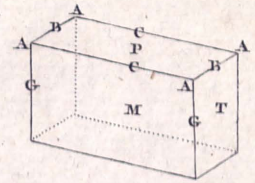

Fig. 105.

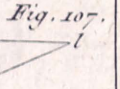
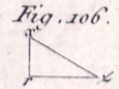
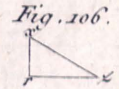

Fig. 106.

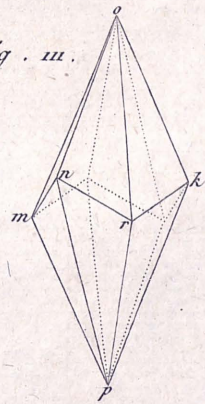

Fig. 107.

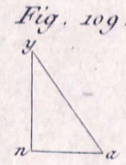

Fig. 108.

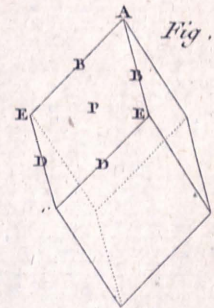

Fig. 109.

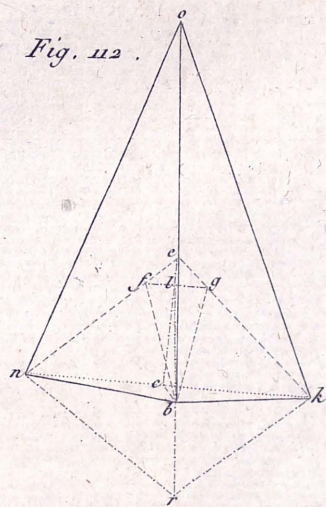

Fig. 110.

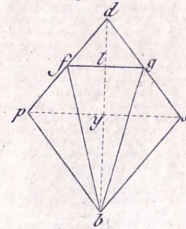

Fig. 111.

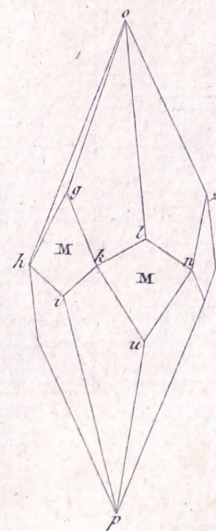

Fig. 112.

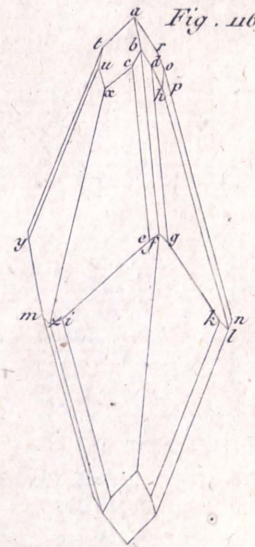
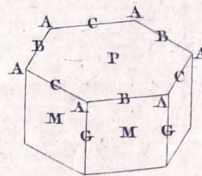
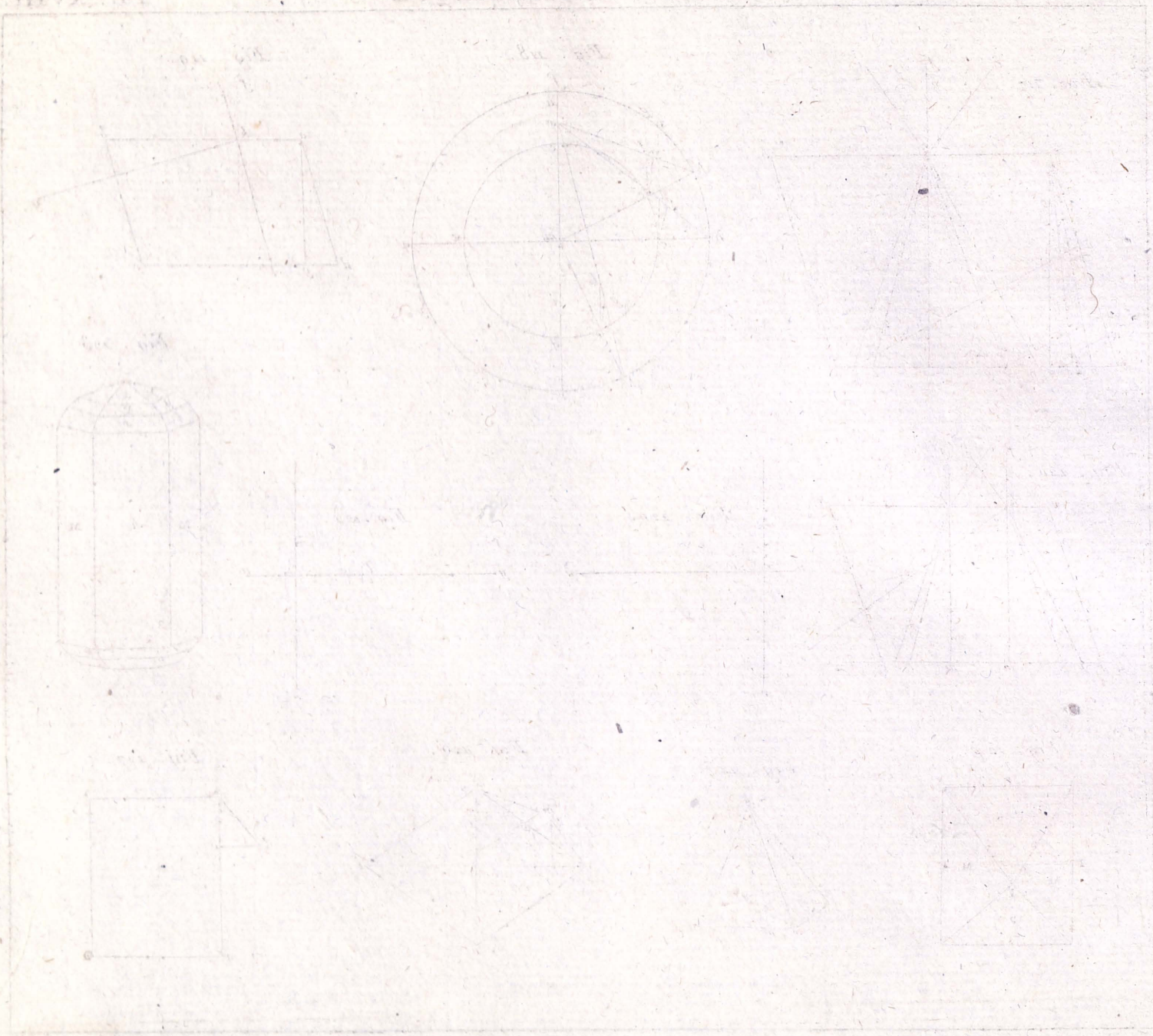

Fig. 113.





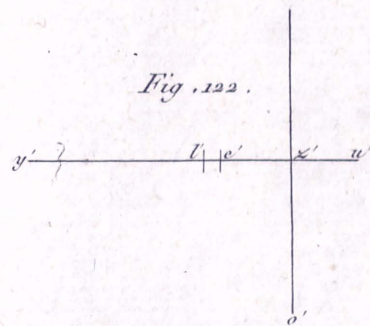
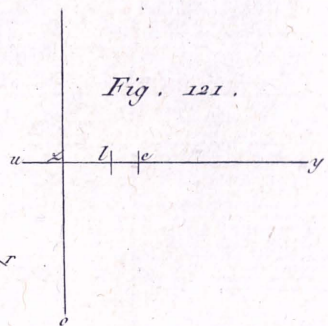
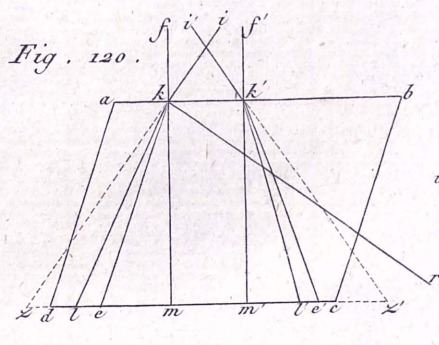
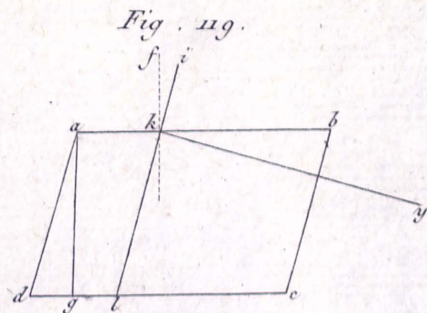
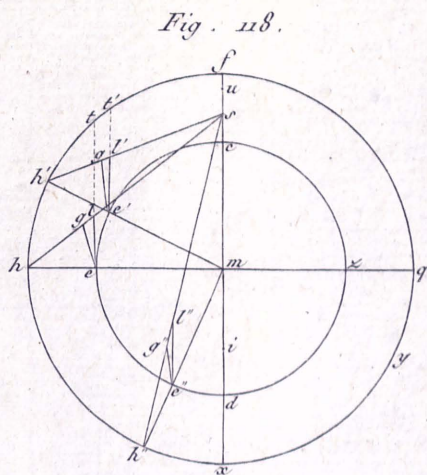
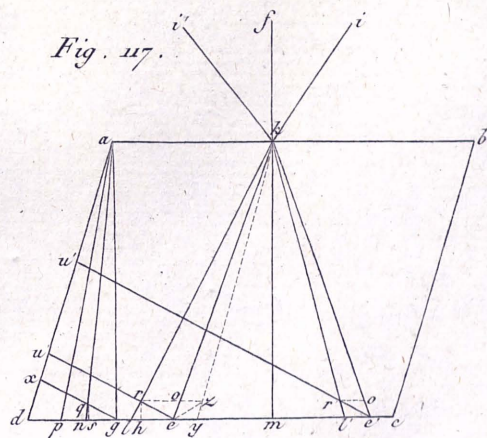

Fig. 123.

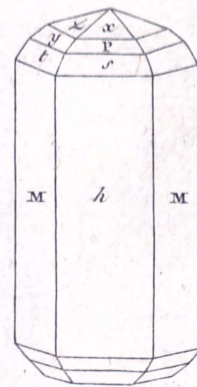

Fig. 124.

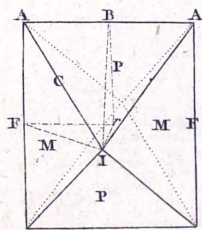

Fig. 125.

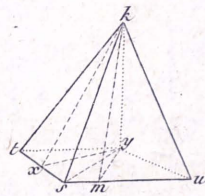

Fig. 126.

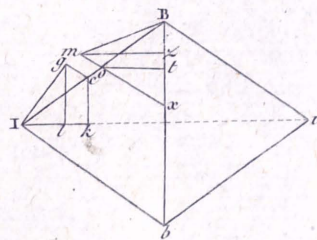
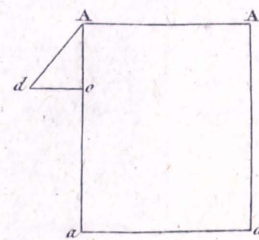

Fig. 127.



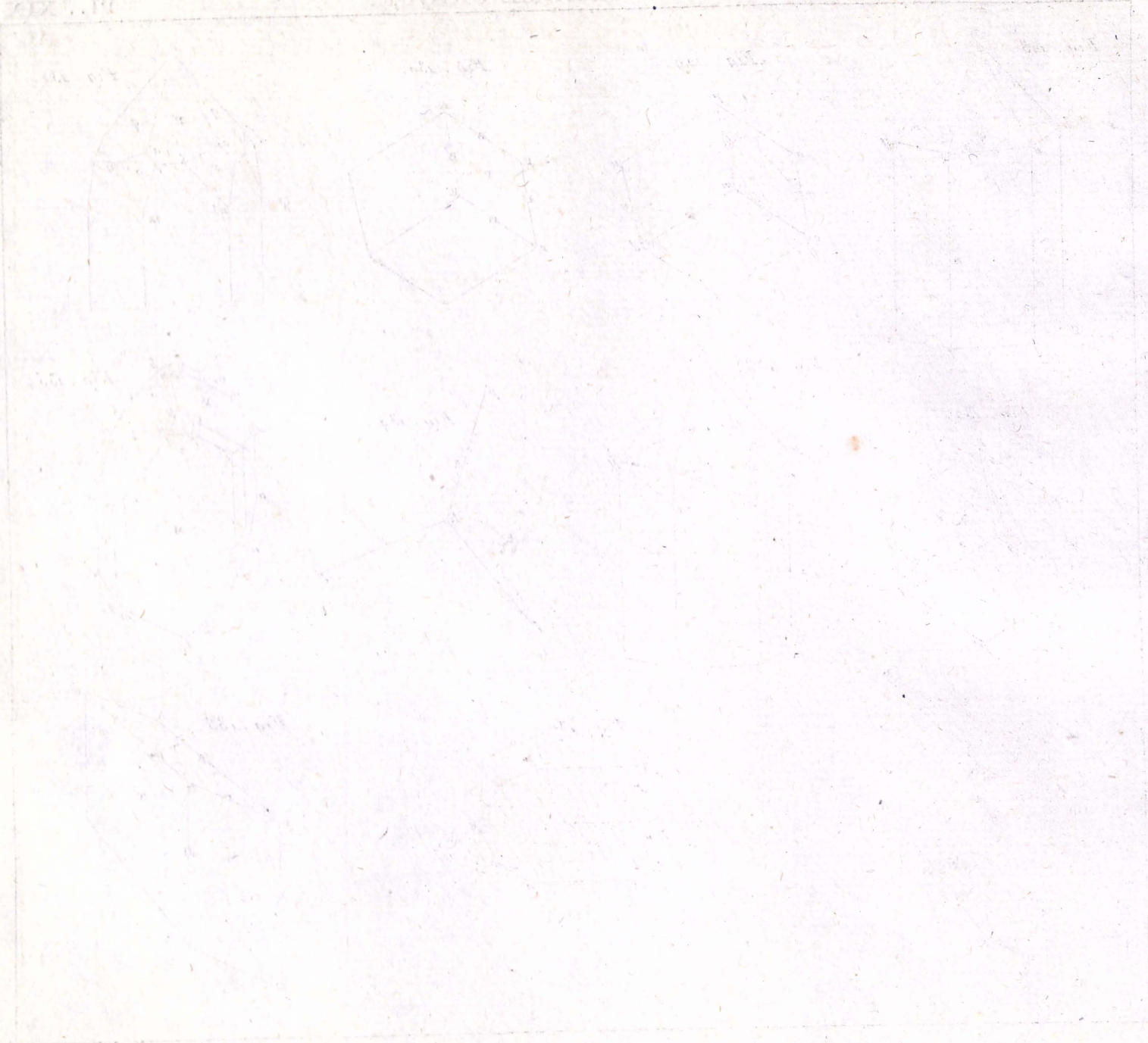

Fig. 128

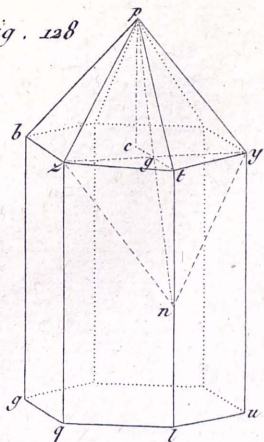

Fig. 129.

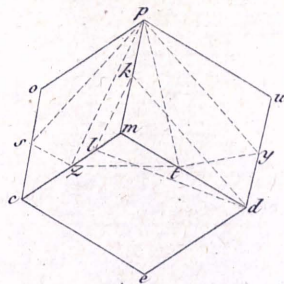

Fig. 130.

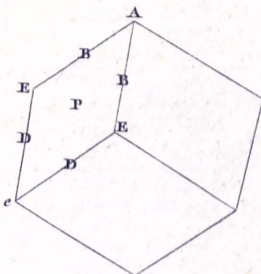

Fig. 131.

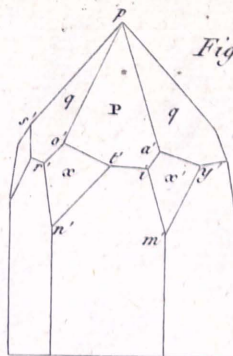

Fig. 132.

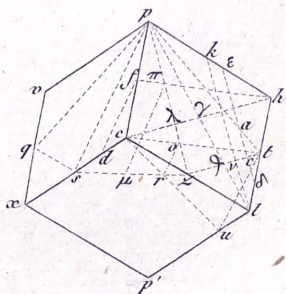

Fig. 133.

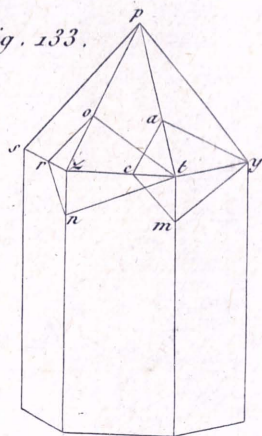

Fig. 134.

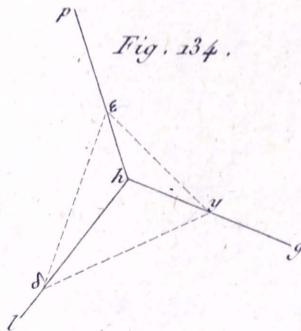

Fig. 135.

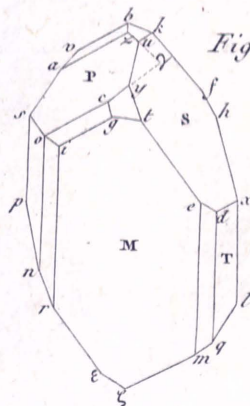

Fig. 136.

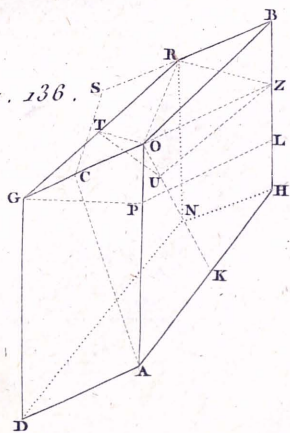

Fig. 137.

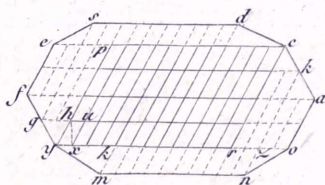
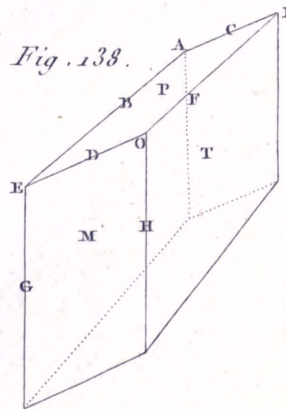

Fig. 138.



17

THE UNIVERSITY OF CHICAGO



Fig. 139.

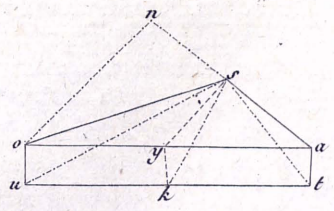

Fig. 140.

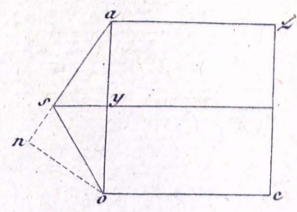

Fig. 141.

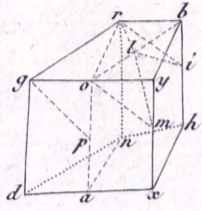

Fig. 142.

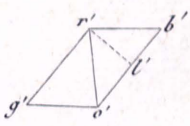

Fig. 143.

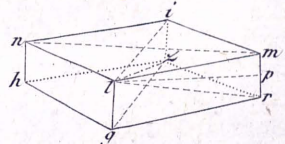

Fig. 144.

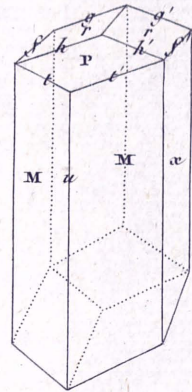

Fig. 145.

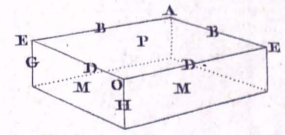

Fig. 146.

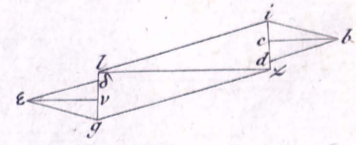

Fig. 147.

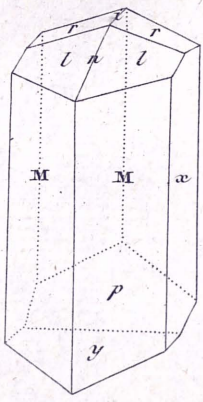

Fig. 148.

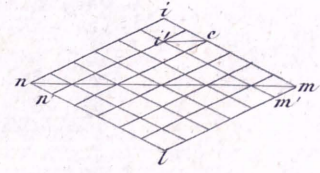

Fig. 149.

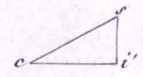

Fig. 10

TABLE OF CONTENTS

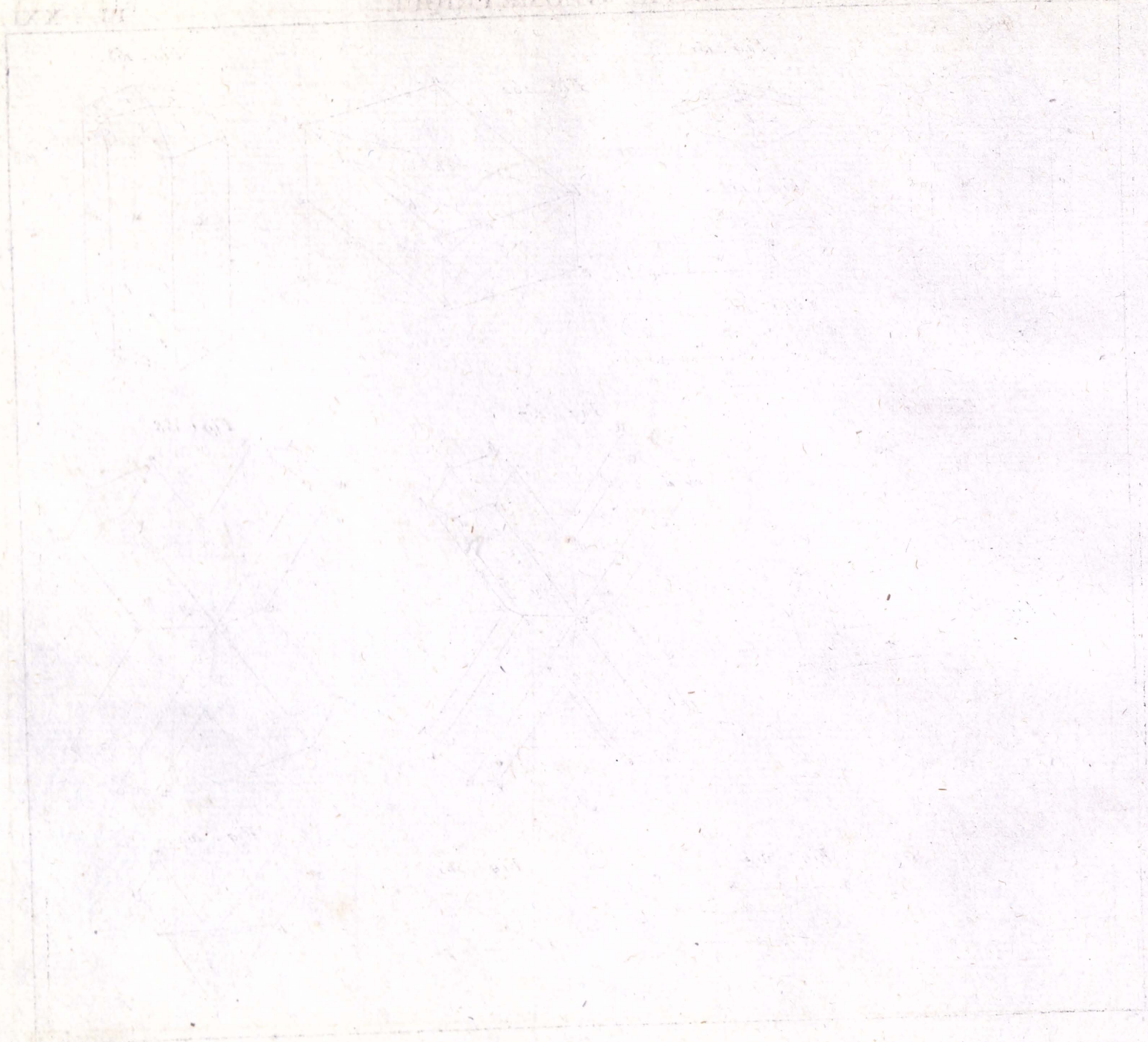

Fig. 150.

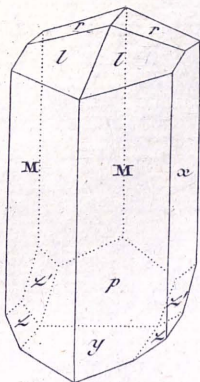

Fig. 151.

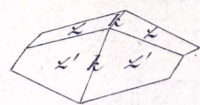

Fig. 152.

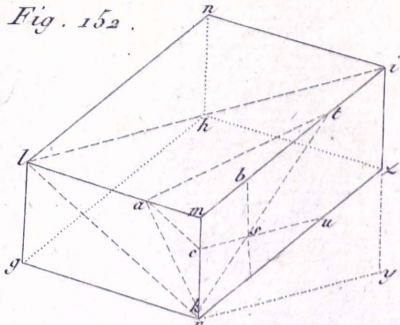

Fig. 154.

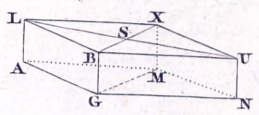

Fig. 155.

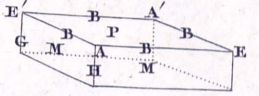

Fig. 153.

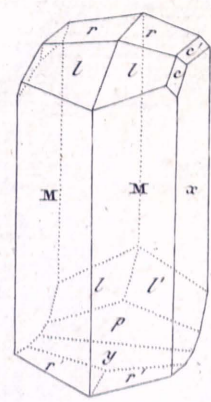

Fig. 156.

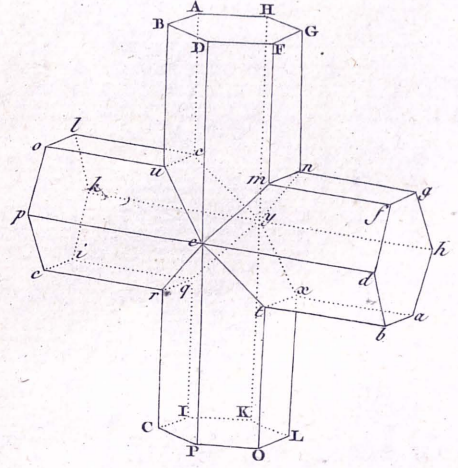

Fig. 157.

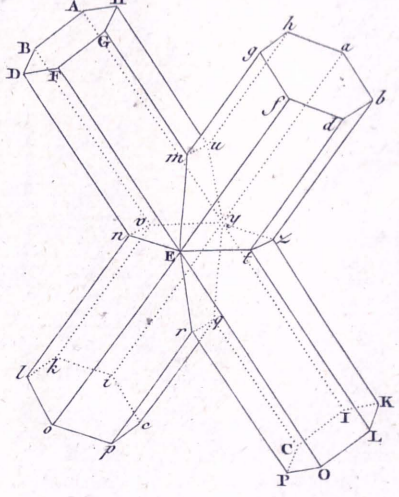

Fig. 158.

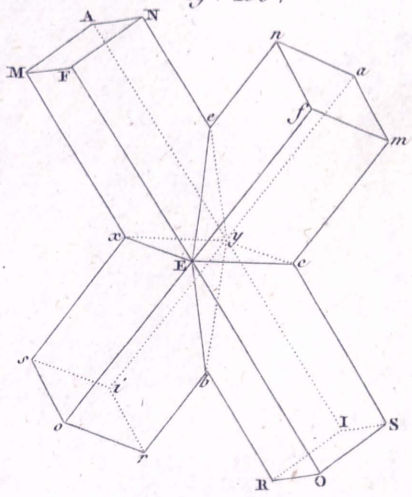

Fig. 159.

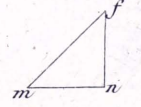

Fig. 160.

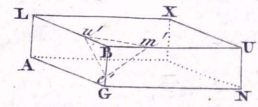

Fig. 161.

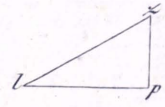
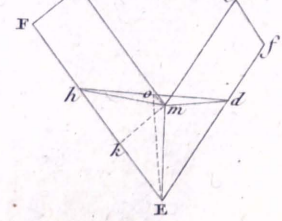
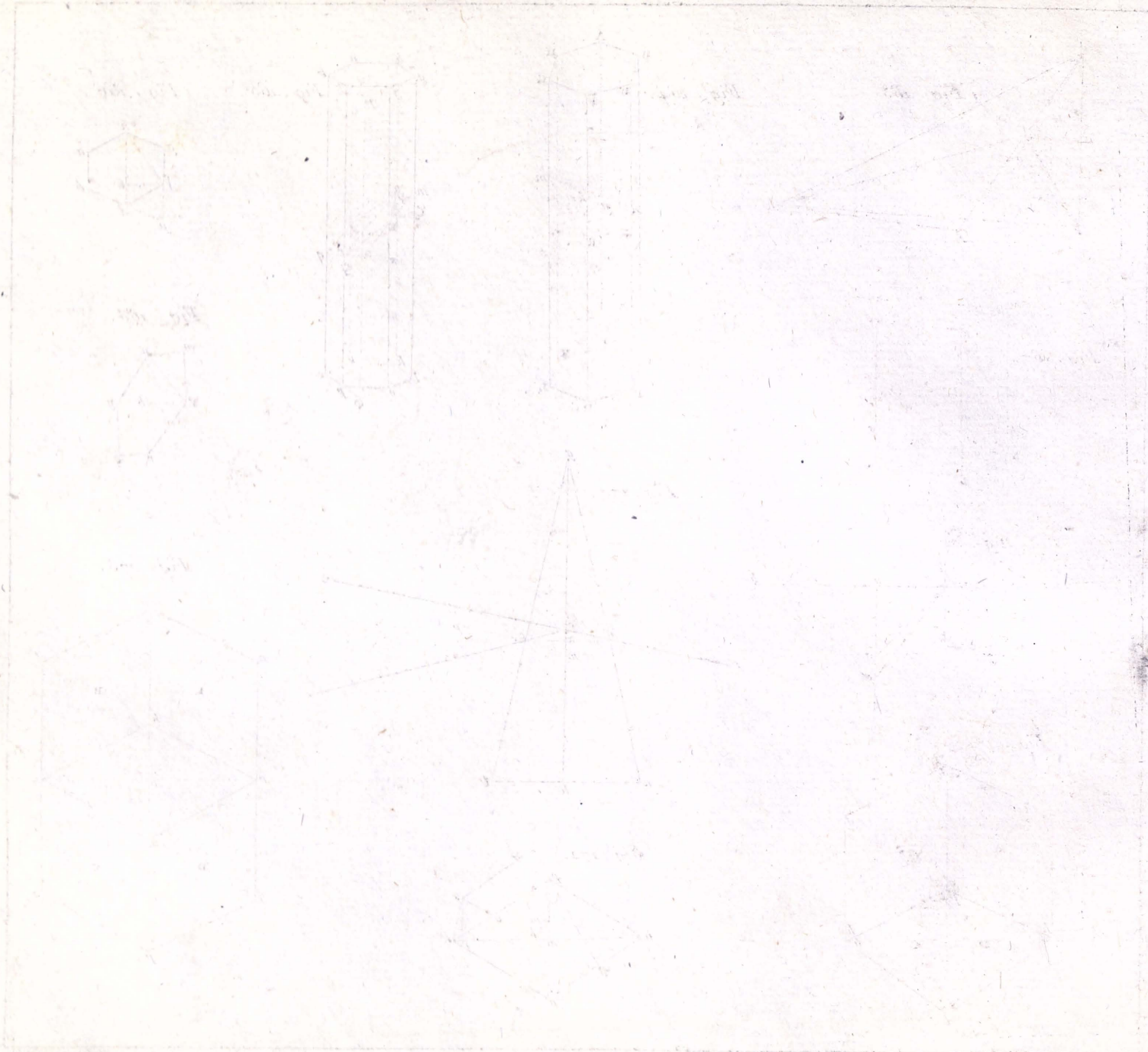

Fig. 162.





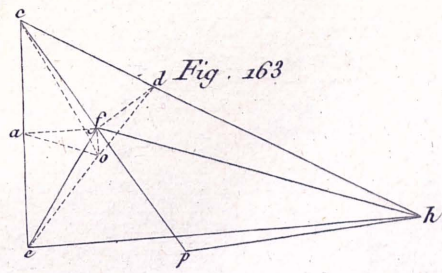

Fig. 164.

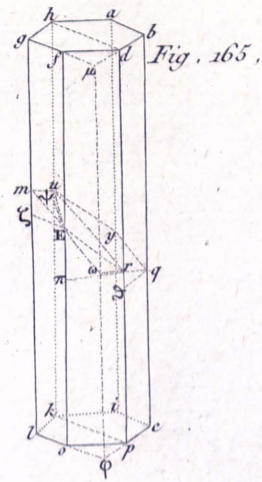
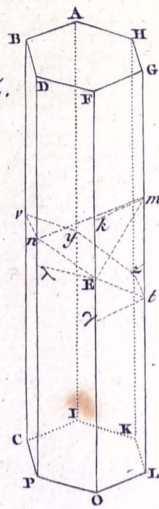

Fig. 166.

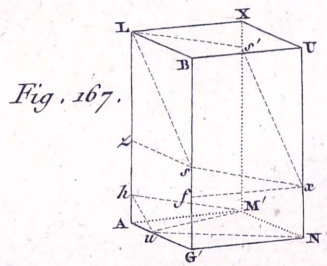
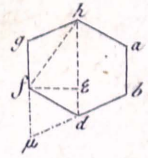

Fig. 167.

Fig. 168.

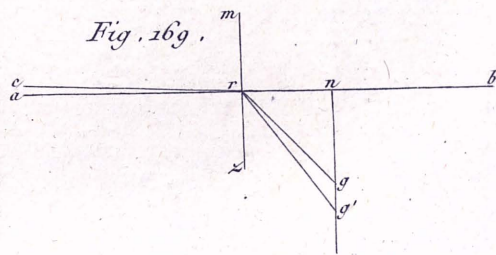
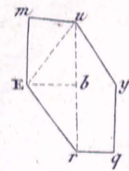

Fig. 169.

Fig. 170.

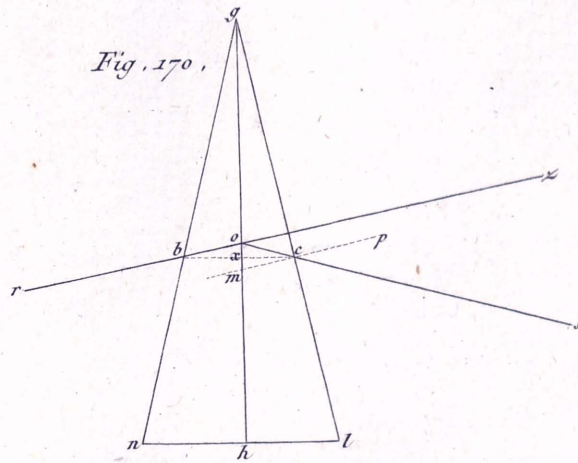

Fig. 173.

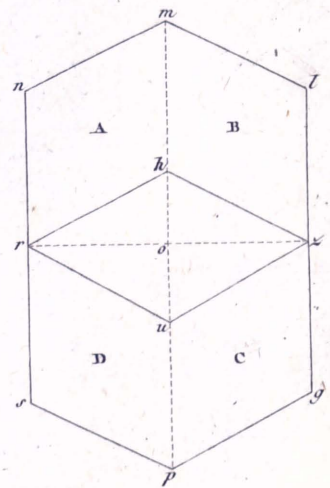

Fig. 171.

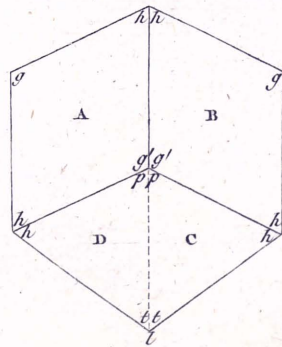

Fig. 172.

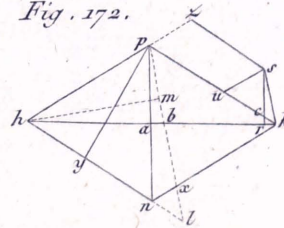

PLATE 19

PLATE 19

PLATE 19



CHAUX CARBONATÉE

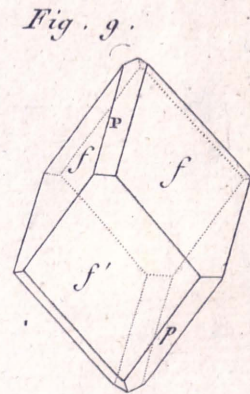
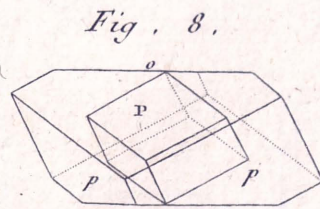
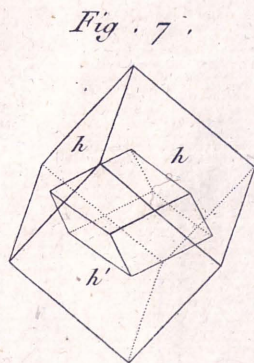
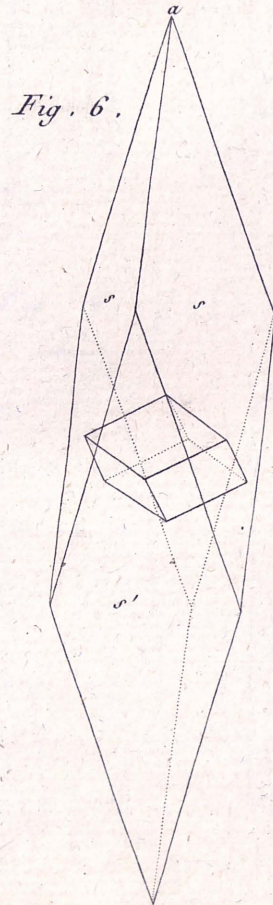
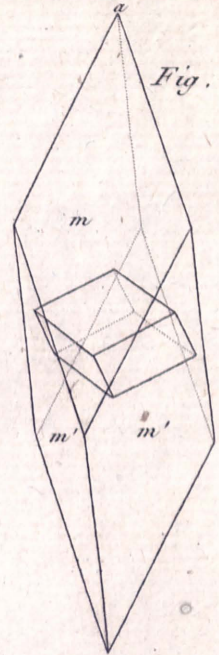
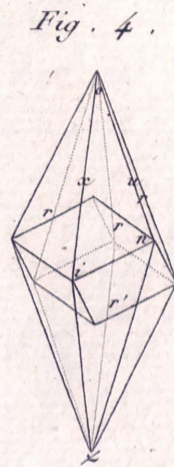
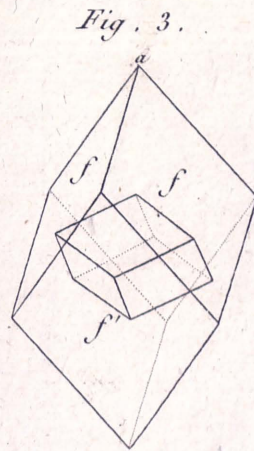
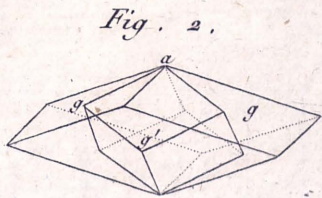
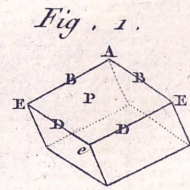

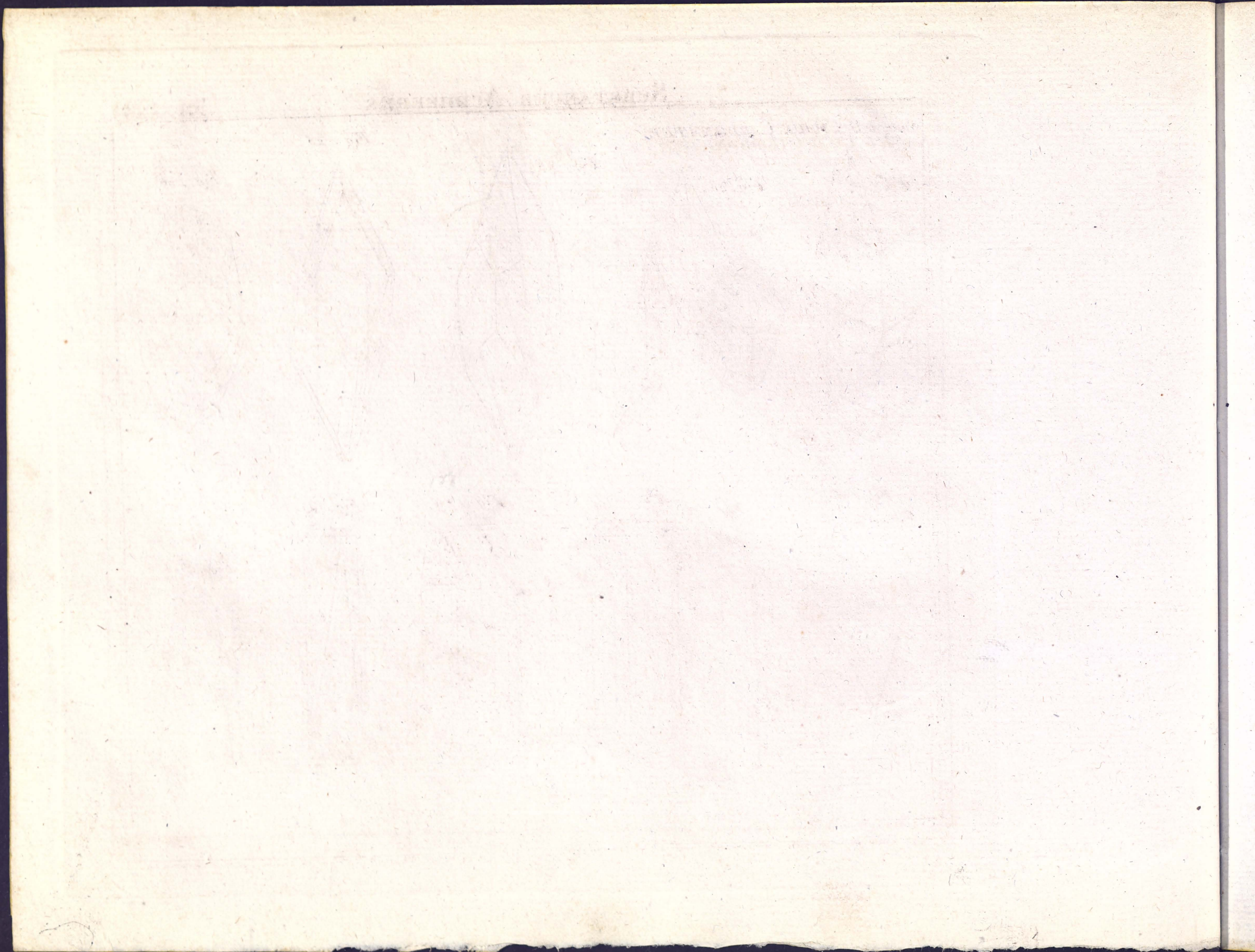

Suite de la CHAUX CARBONATÉE

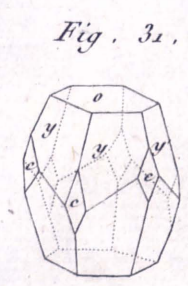
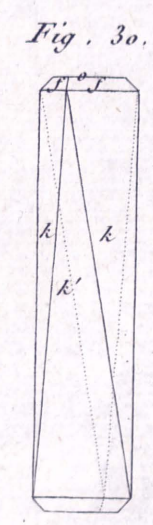
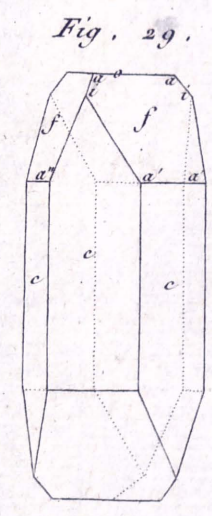
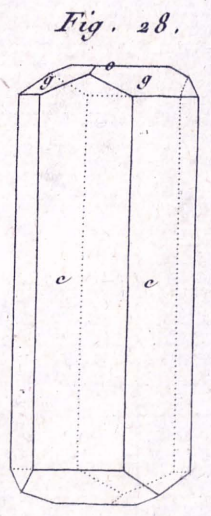
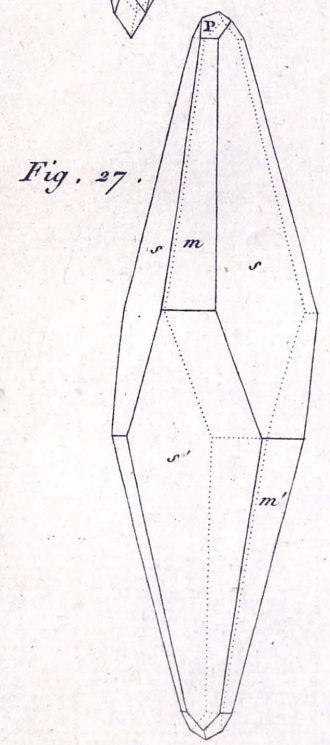
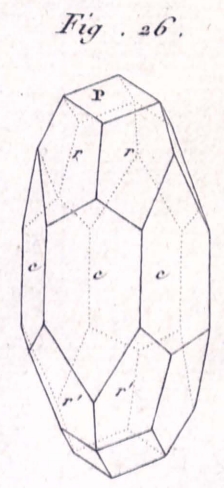
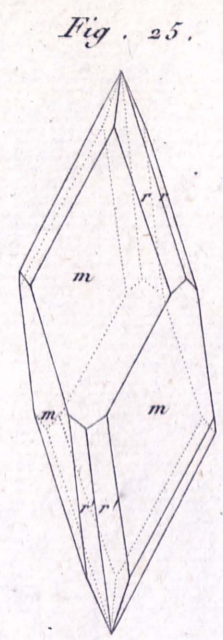
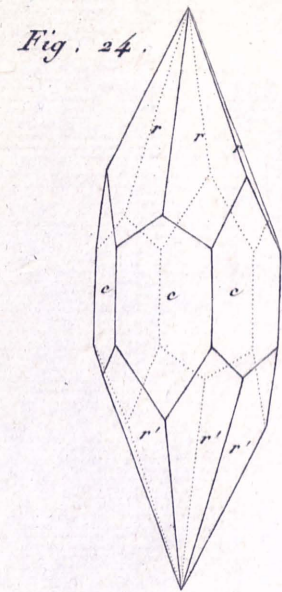
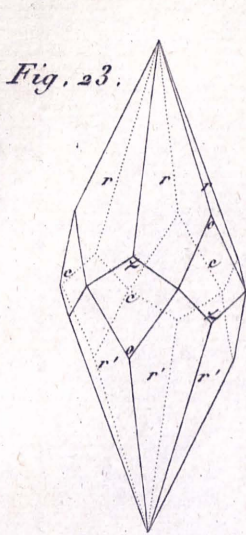
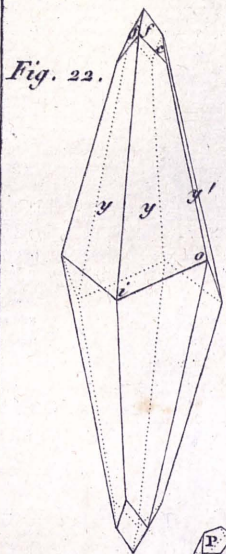

1772

MINERALOGY

PLATE I



Suite de la CHAUX CARBONATÉE

Fig. 32.

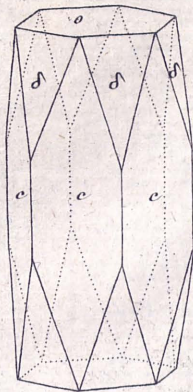

Fig. 33.

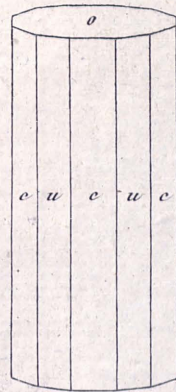

Fig. 34.

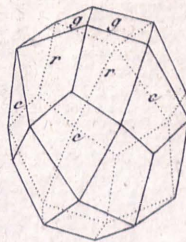

Fig. 35.

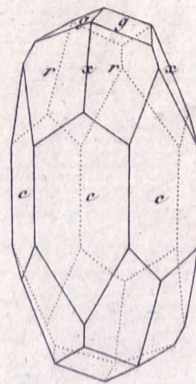

Fig. 36.

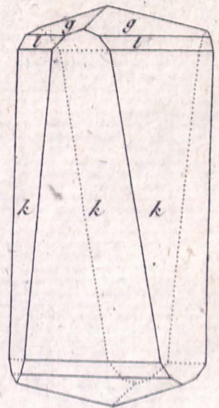

Fig. 37.

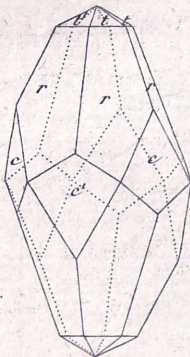

Fig. 38.

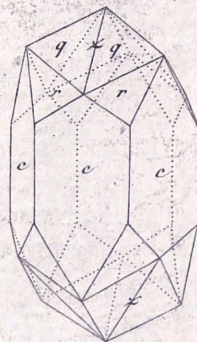

Fig. 39.

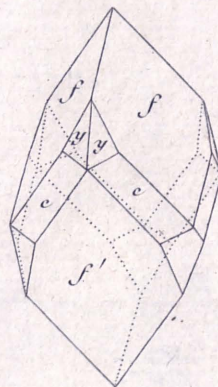
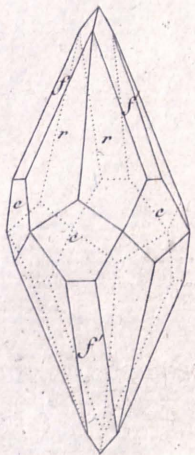

Fig. 40.



PL. XXVII

TABLEAU DES CRISTALLS

DE LA CLASSE DES CRISTALLS



Suite de la CHAUX CARBONATÉE

Fig. 41.

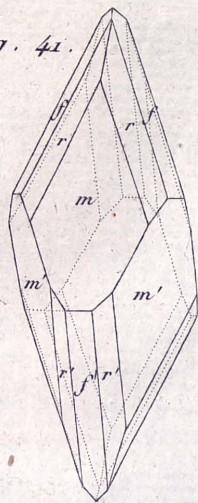

Fig. 42.

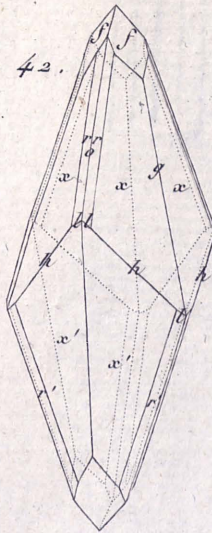

Fig. 43.

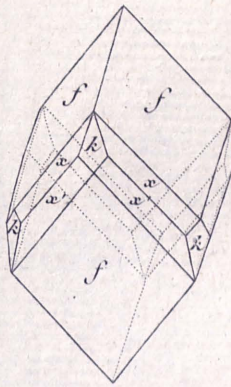

Fig. 44.

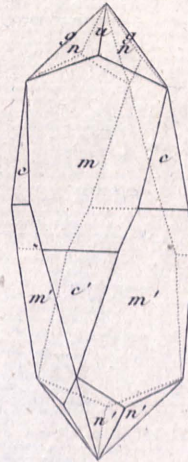

Fig. 45.

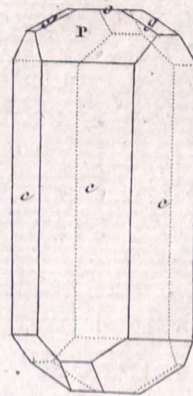

Fig. 46.

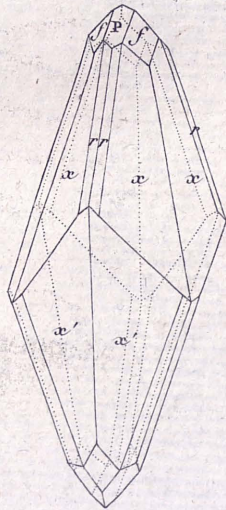

Fig. 47.

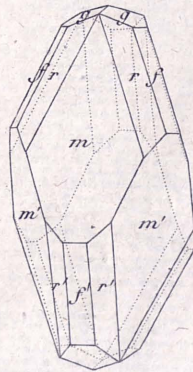

Fig. 48.

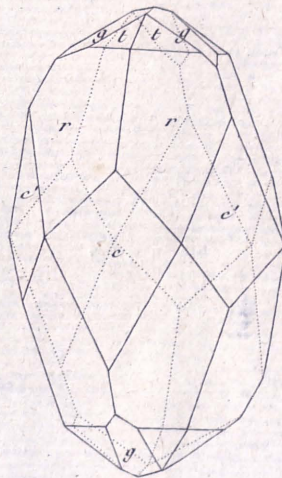
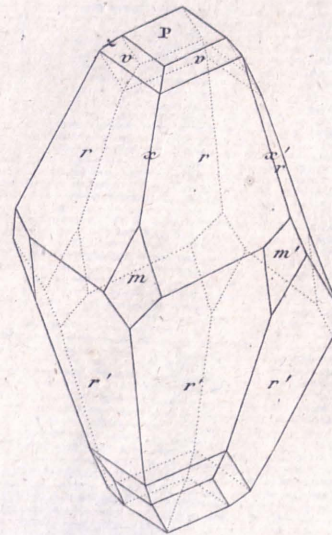
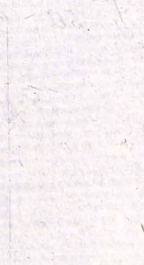
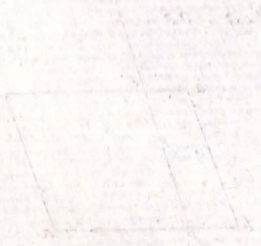

Fig. 49.



JOHN'S BARRINGTON

THE GREAT CARPENTER



Suite de la CHAUX CARBONATEE

DOUBLE REFRACTION

Fig. 50.

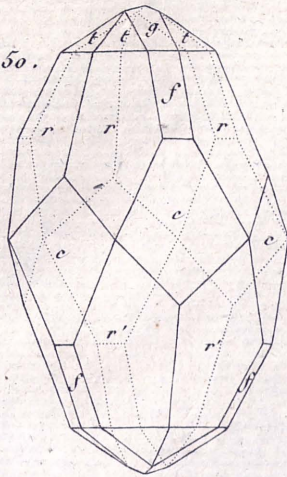

Fig. 51.

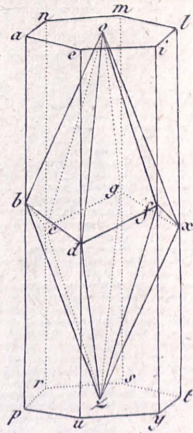

Fig. 52.

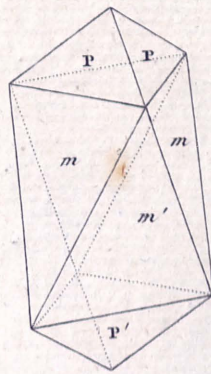

Fig. 53.

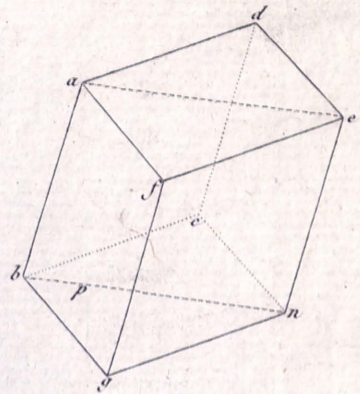

Fig. 54.

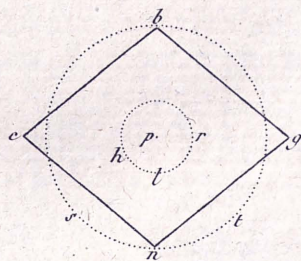

Fig. 57.

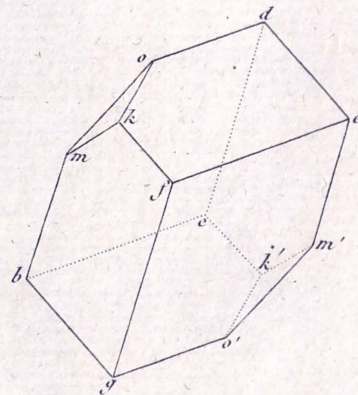

Fig. 55.

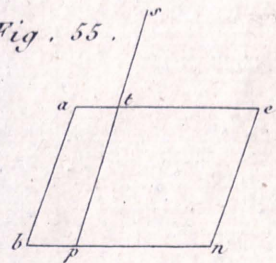

Fig. 56.

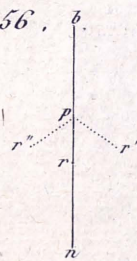
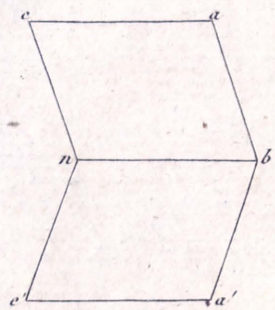

Fig. 58.



1
2
3
4
5
6
7
8
9
10
11
12
13
14
15
16
17
18
19
20
21
22
23
24
25
26
27
28
29
30
31
32
33
34
35
36
37
38
39
40
41
42
43
44
45
46
47
48
49
50
51
52
53
54
55
56
57
58
59
60
61
62
63
64
65
66
67
68
69
70
71
72
73
74
75
76
77
78
79
80
81
82
83
84
85
86
87
88
89
90
91
92
93
94
95
96
97
98
99
100



Suite de la CHAUX CARBONATÉE

Fig. 59.

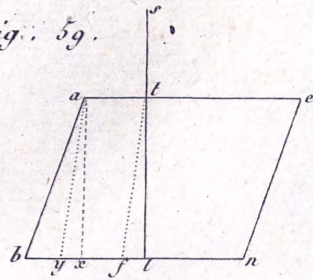

Fig. 60.

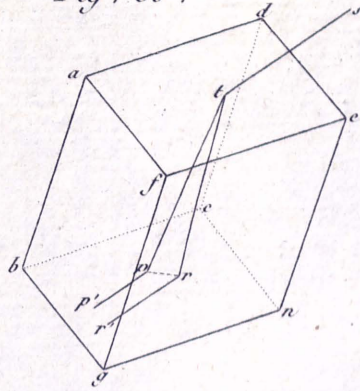

Fig. 61.

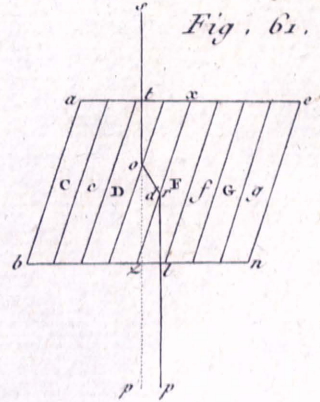

Fig. 63.

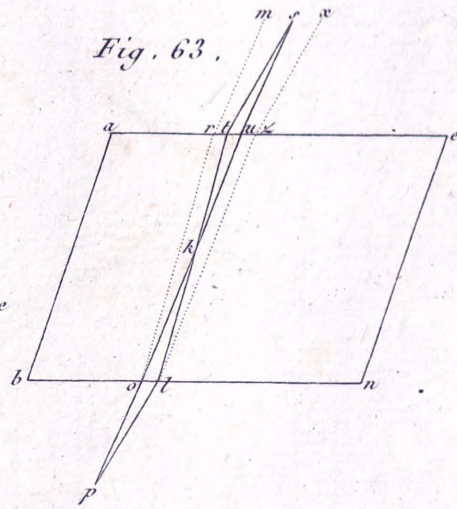

Fig. 62.

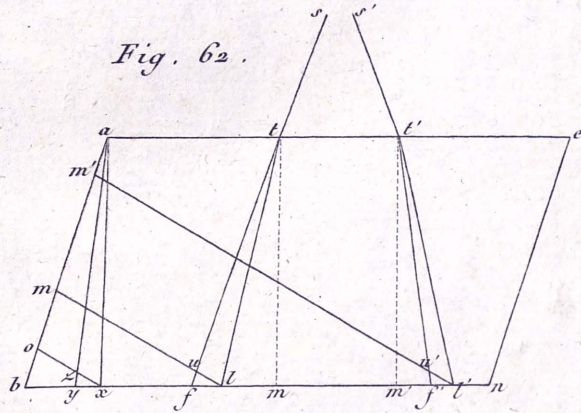

Fig. 64.

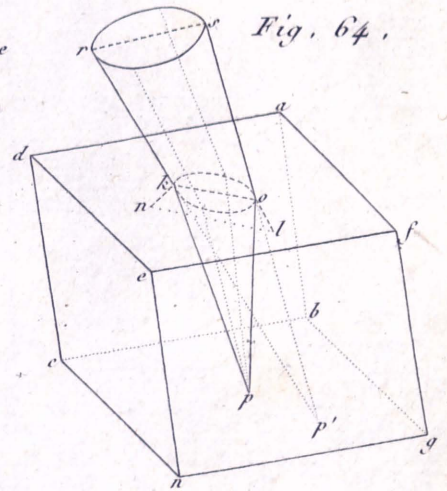
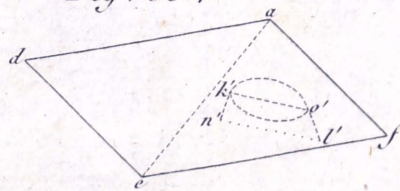
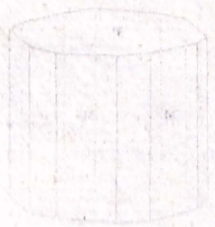

Fig. 65.



DESCRIPTIO LUCIDISS.

DESCRIPTIO LUCIDISS.



CHAUX PHOSPHATEE

Fig. 66.

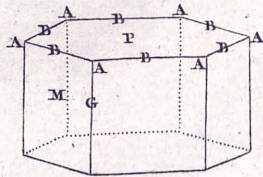

Fig. 67.

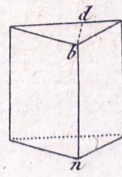

Fig. 68.

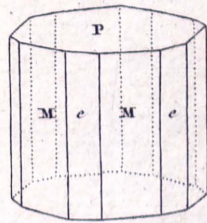

Fig. 69.

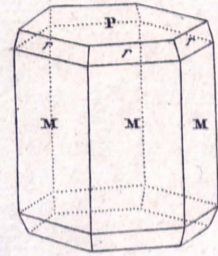

Fig. 70.

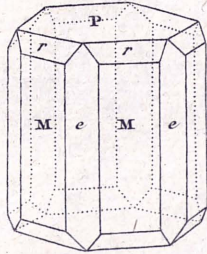

Fig. 71.

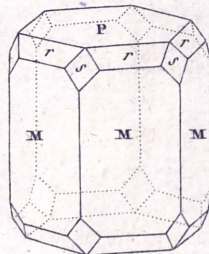

Fig. 72.

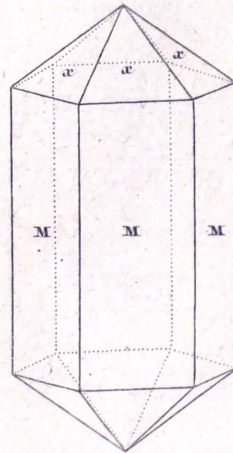

Fig. 73.

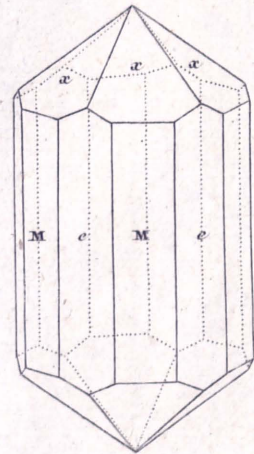
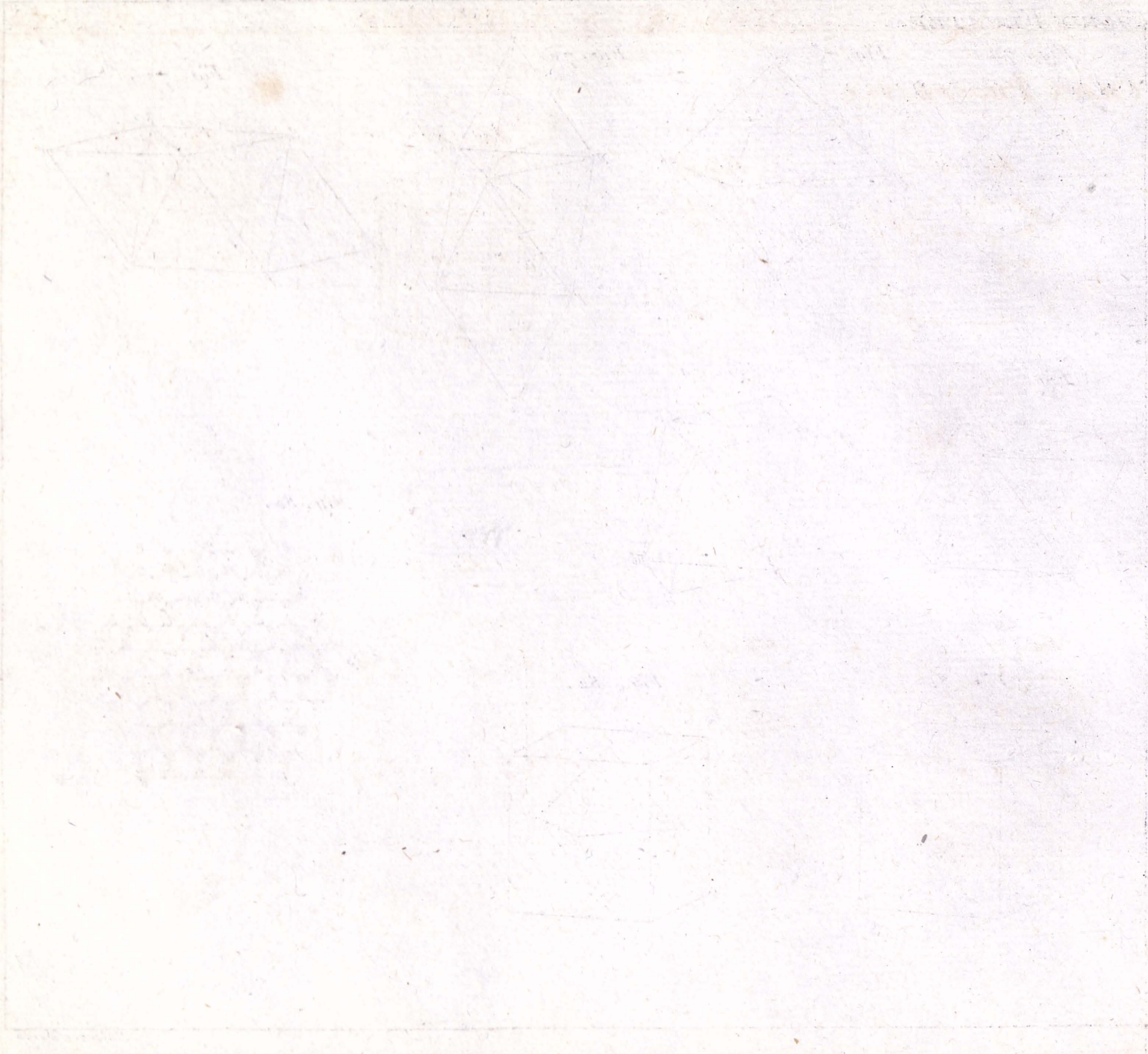

PLATE 1

PLATE 1



CHAUX FLUATÉE

Fig. 74.

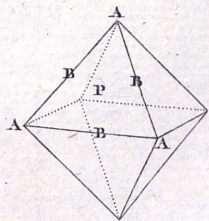

Fig. 75.

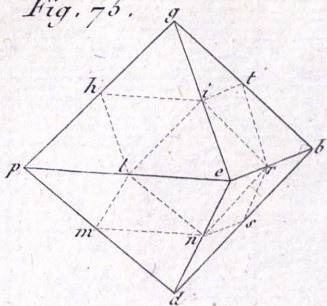

Fig. 76.

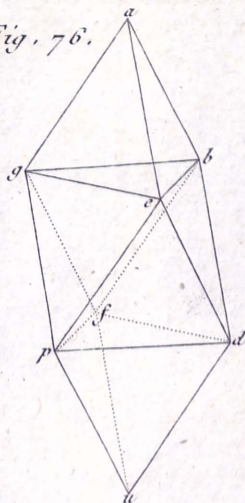

Fig. 77.

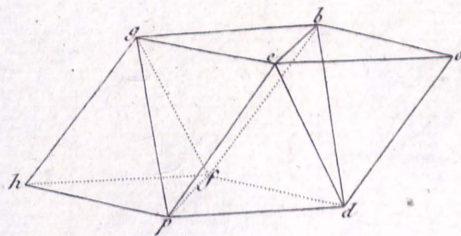

Fig. 78.

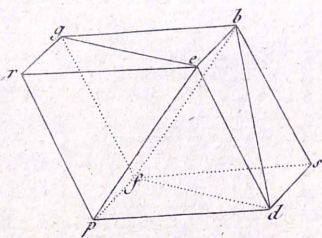

Fig. 79.

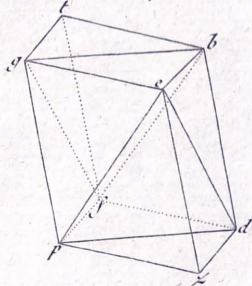

Fig. 80.

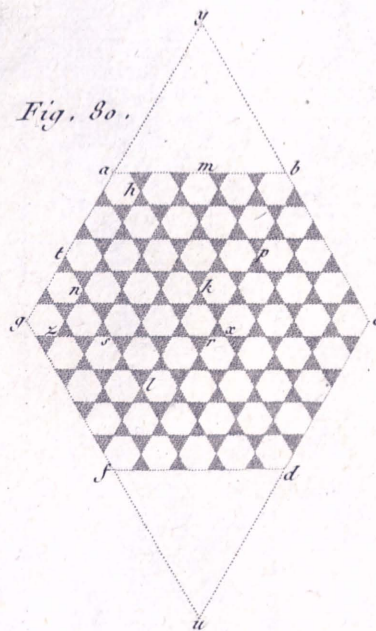

Fig. 81.

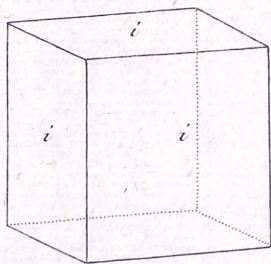
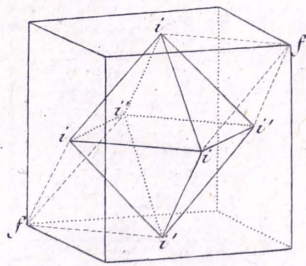
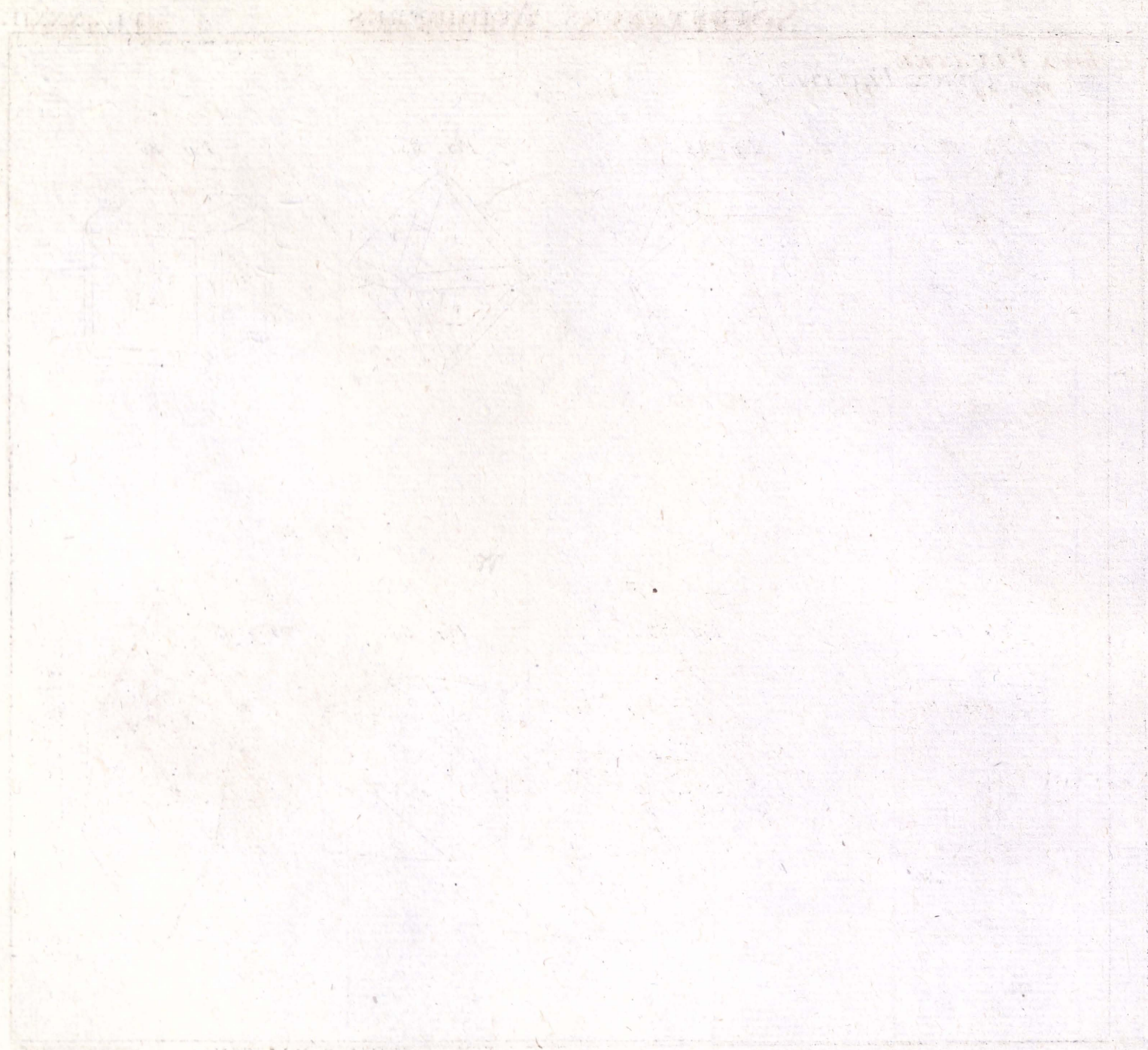

Fig. 82.





Suite de la CHAUX FLUATÉE

Fig. 83.

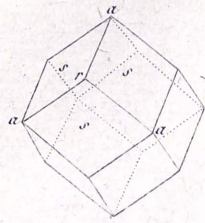

Fig. 84.

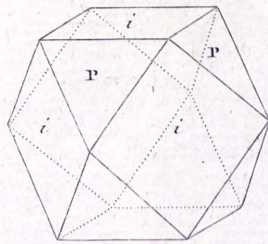

Fig. 85.

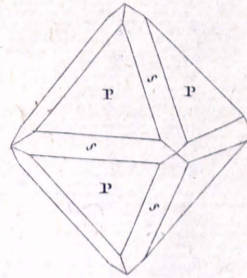

Fig. 86.

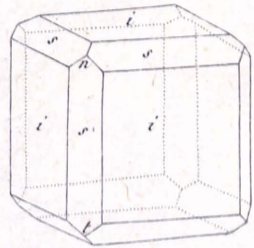

Fig. 87.

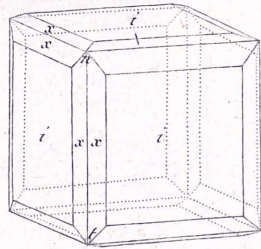

Fig. 88.

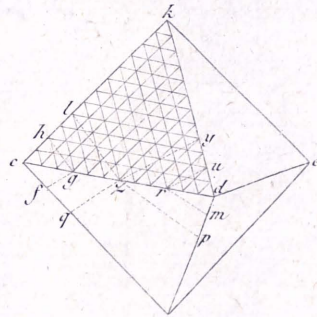

Fig. 89.

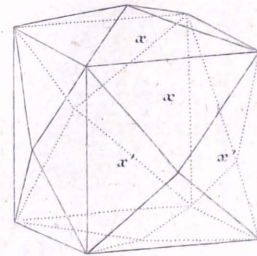
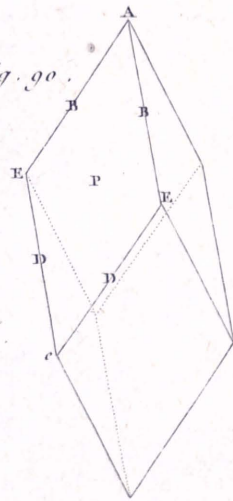
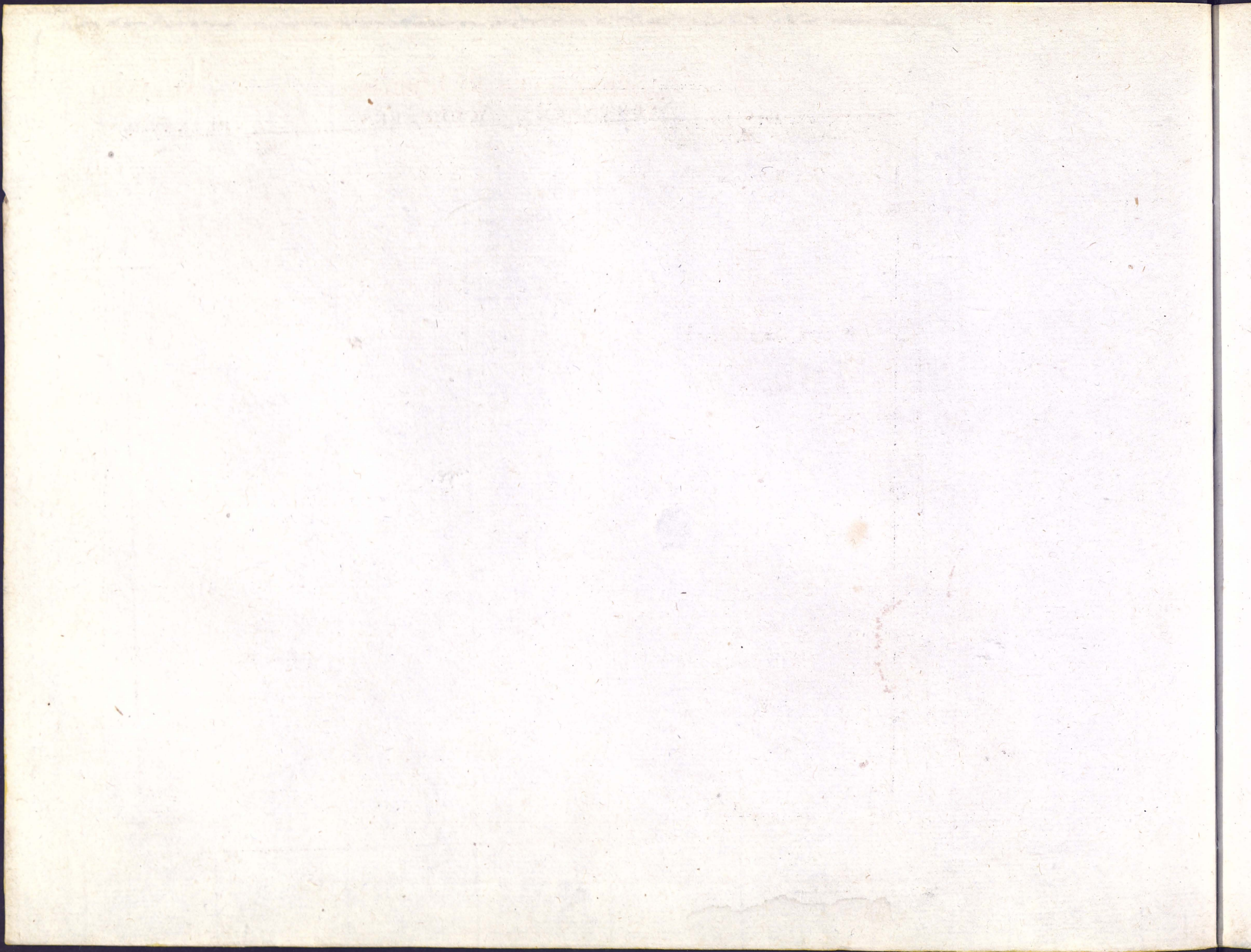

Fig. 90.





MAGNESIE BORATEE

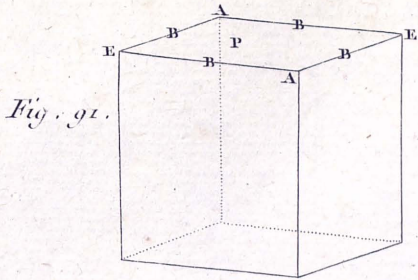

Fig. 92.

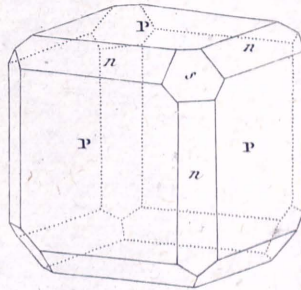
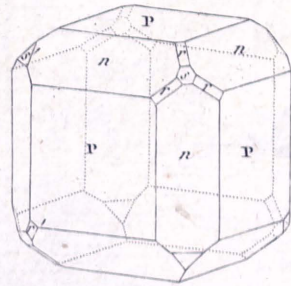

Fig. 93.



CHAUX SULFATEE

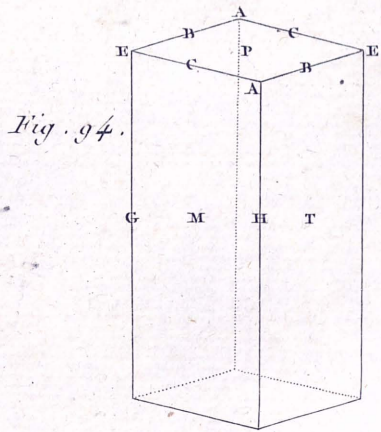

Fig. 96.

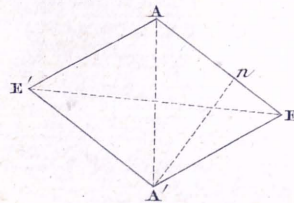
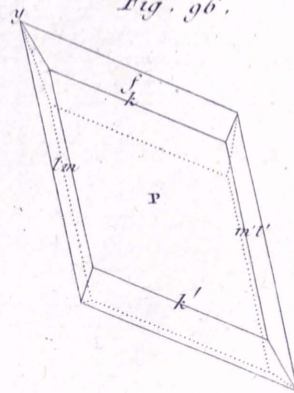

Fig. 97.

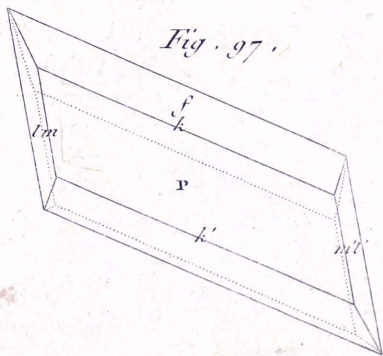
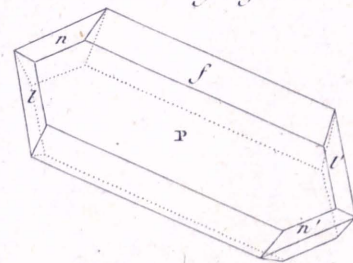

Fig. 98.



1777

STURM UND DRANG

UND AUF DER GEBIRGE



Suite de la CHAUX SULFATEE

Fig. 99.

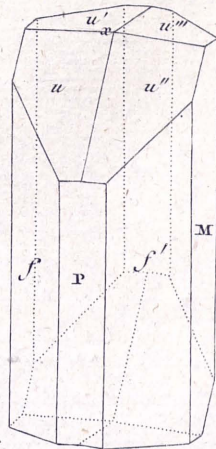

Fig. 100.

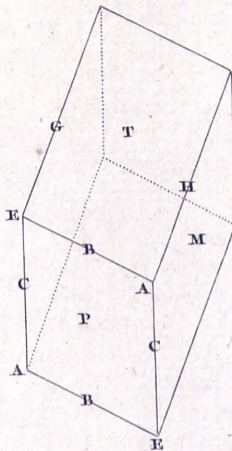

Fig. 102.

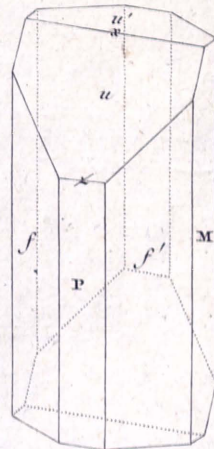

Fig. 101.

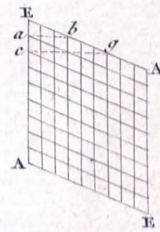

Fig. 103.

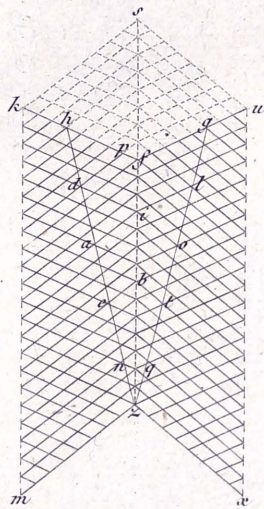

Fig. 104.

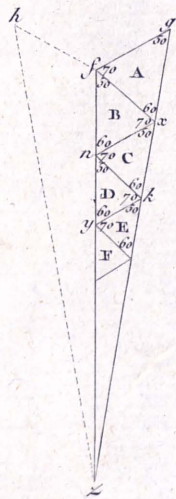

Fig. 105.

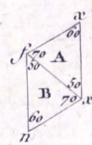

Fig. 106.

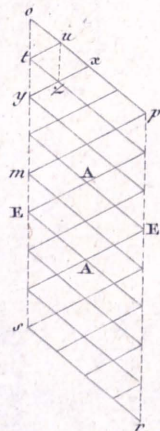

PLATE 1

THE GREAT WALL OF CHINA

SECTION I



BARYTE SULFATÉE

Fig. 107.

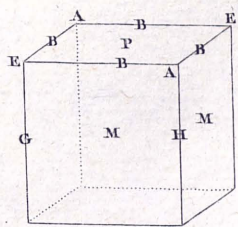

Fig. 108.

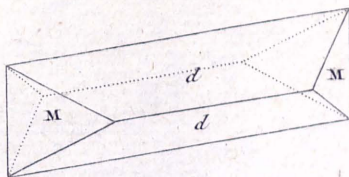

Fig. 109.

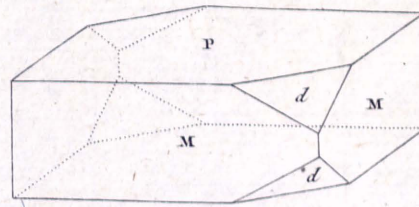

Fig. 110.

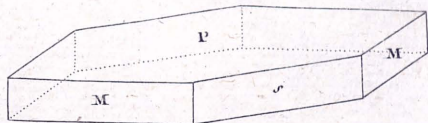

Fig. 111.

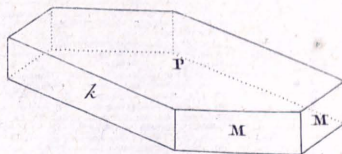

Fig. 112.

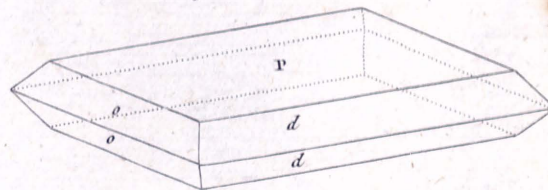

Fig. 113.

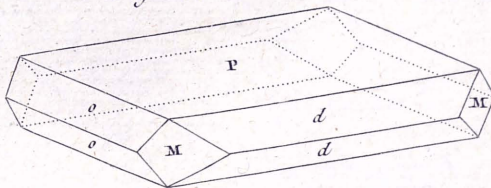

Fig. 114.

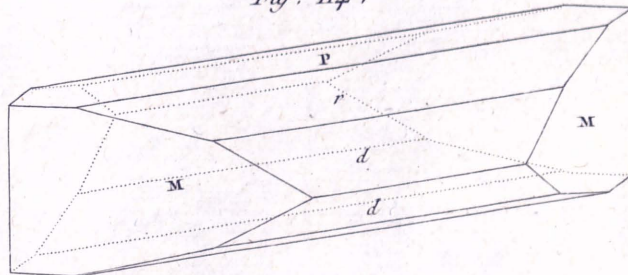

Fig. 115.

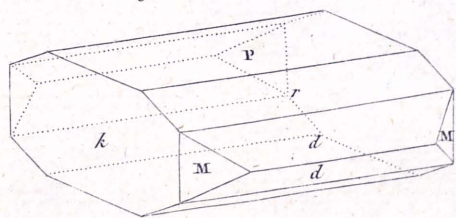

Fig. 116.

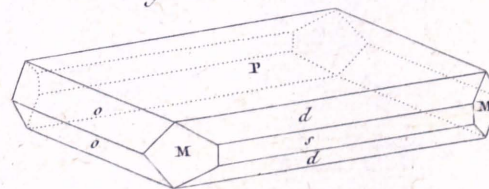
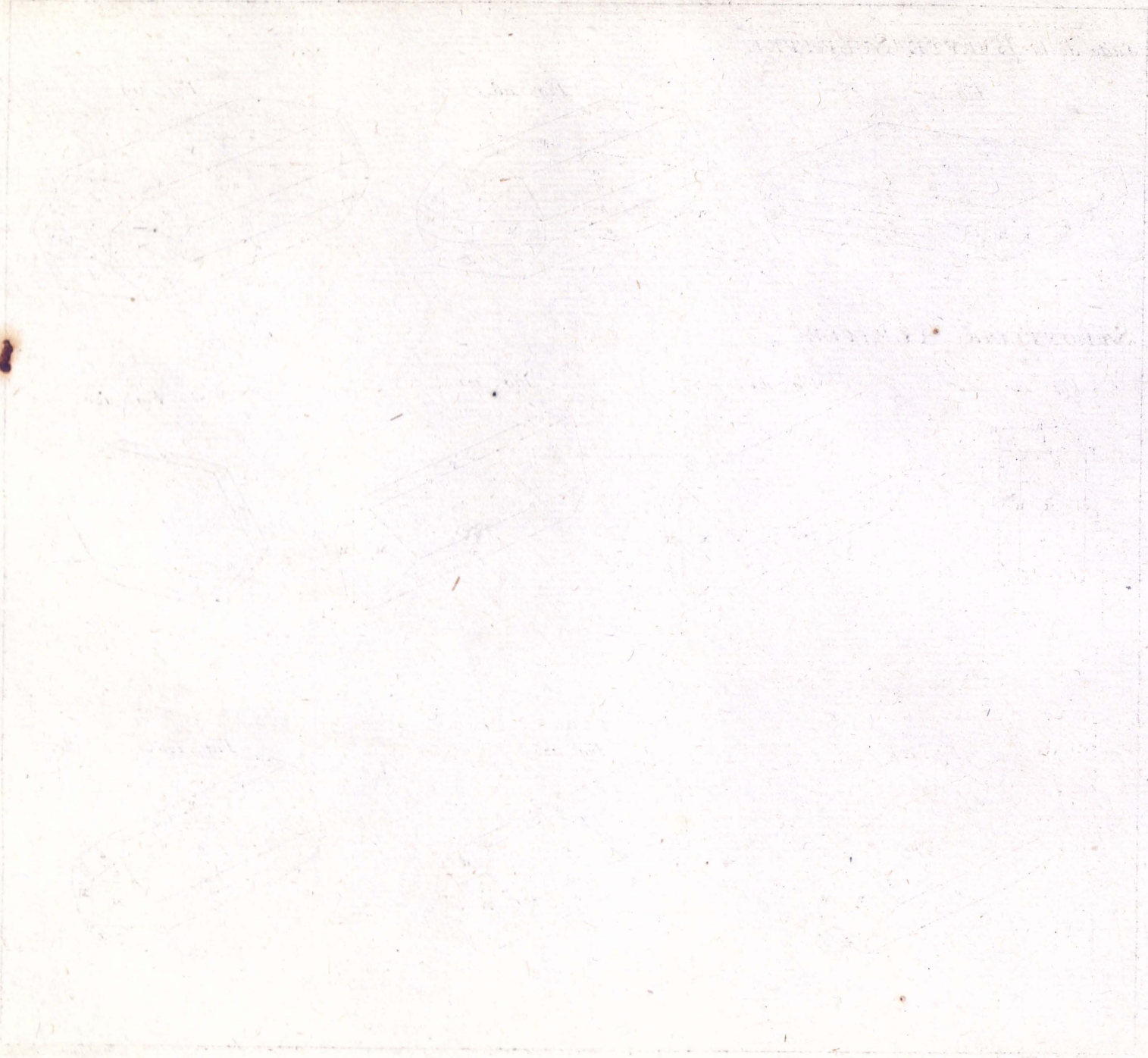

PLATE I



Suite de la BARYTE SULFATÉE

Fig. 117.

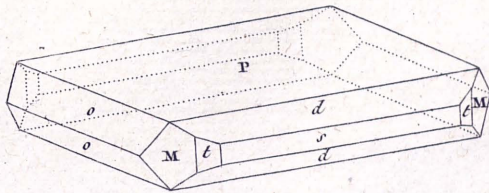

Fig. 118.

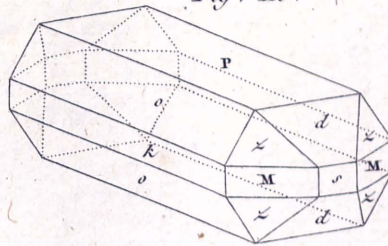
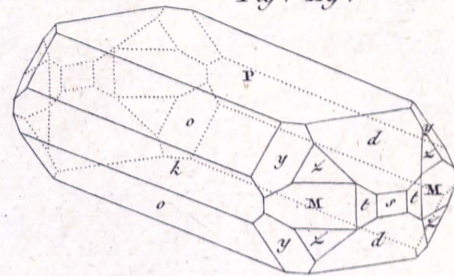

Fig. 119.



STRONTIANE SULFATÉE

Fig. 120.

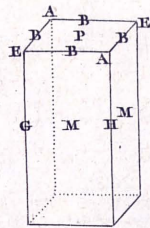

Fig. 121.

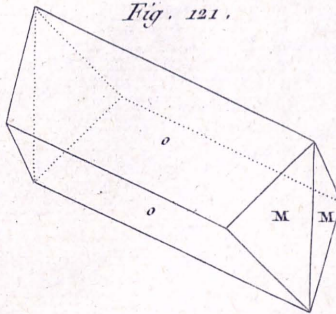

Fig. 122.

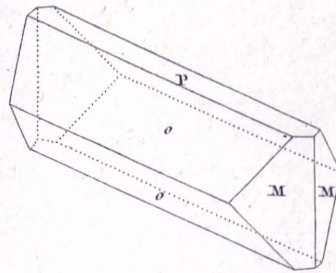

Fig. 123.

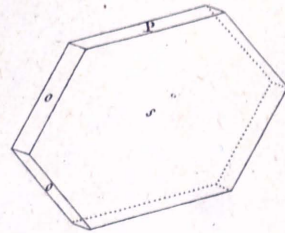

Fig. 124.

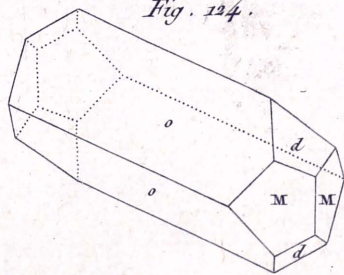

Fig. 125.

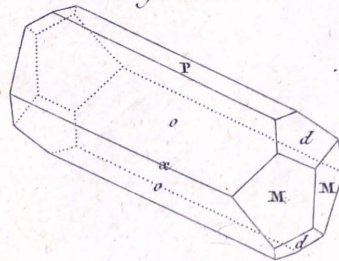

Fig. 126.

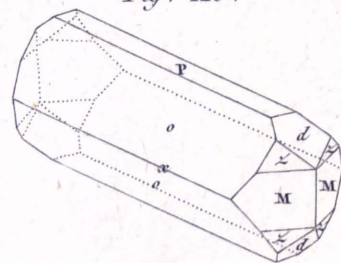

PLATE XXXII

THE GREAT BRITAIN



Suite de la STRONTIANE SULFATÉE

Fig. 128.

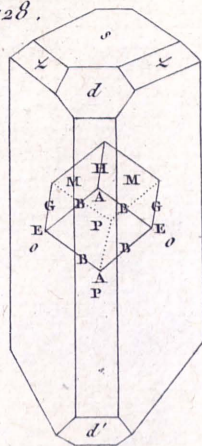

Fig. 129.

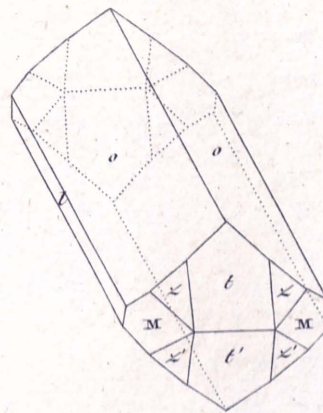

Fig. 130.

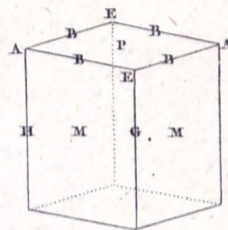
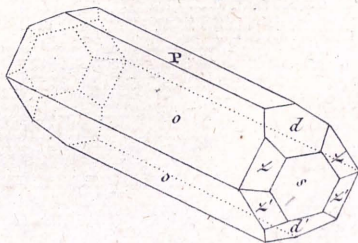

Fig. 127.



MAGNESIE SULFATÉE

Fig. 132.

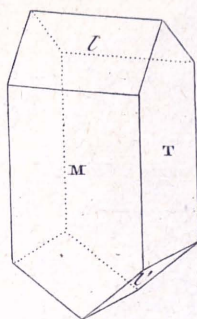

Fig. 133.

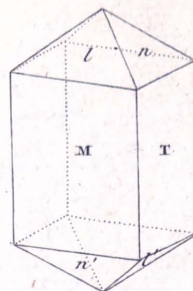

Fig. 134.

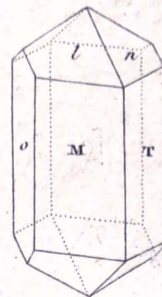

Fig. 131.

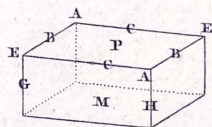

Fig. 136.

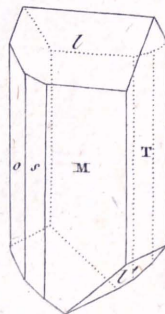

Fig. 137.

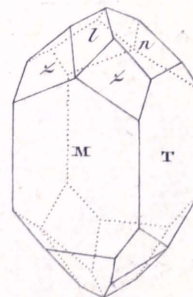

Fig. 135.

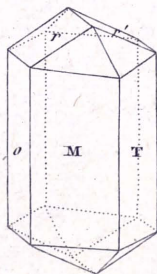
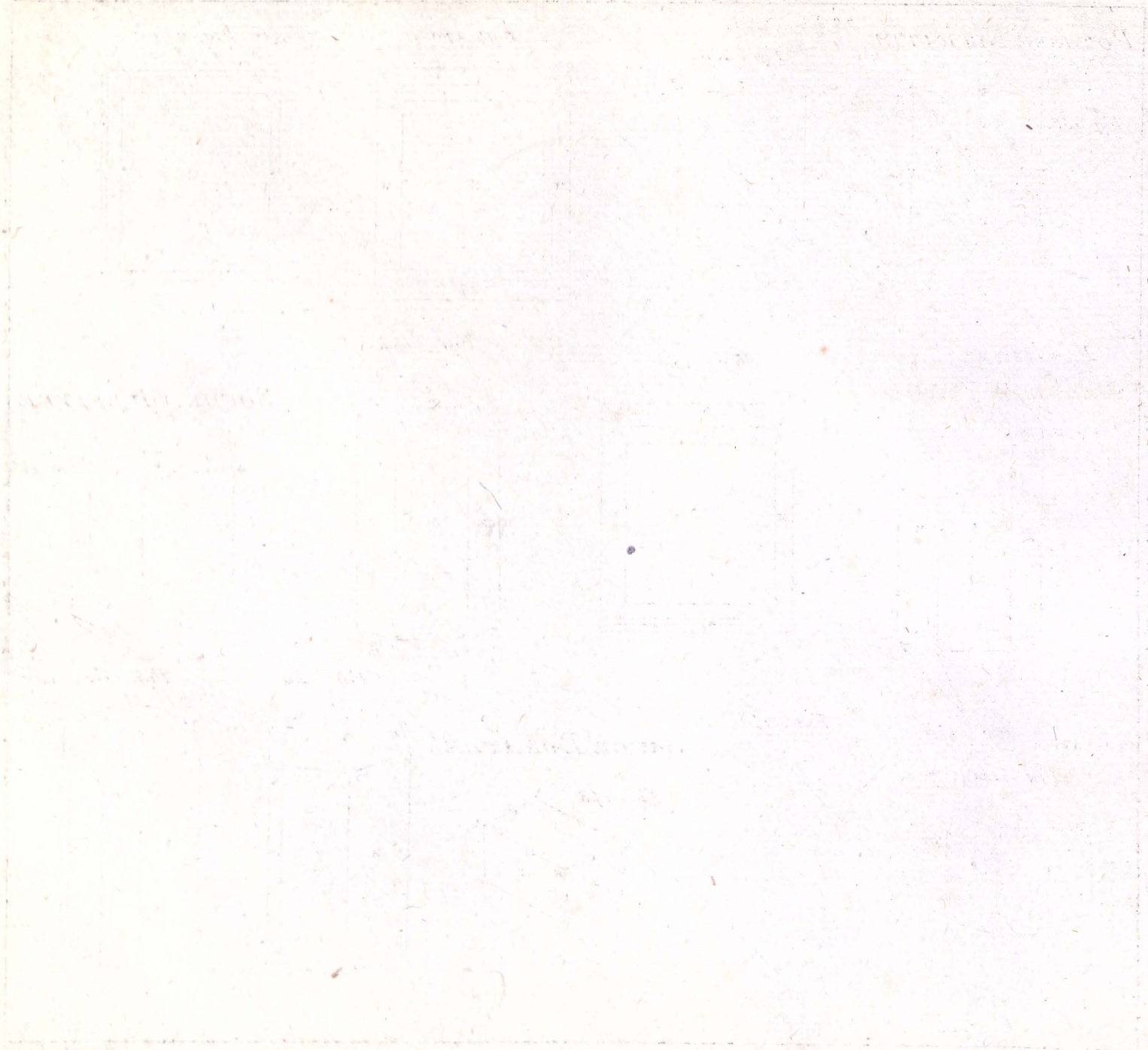

PLATE I. THE TEMPLE OF SATURN AT CAPUA.



POTASSE NITRATÉE

Fig. 138.

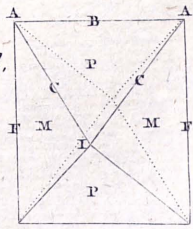

Fig. 139.

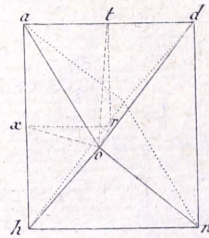

Fig. 140.

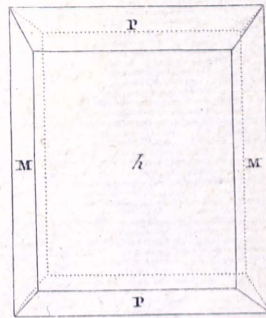

Fig. 141.

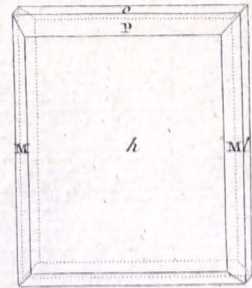

Fig. 142.

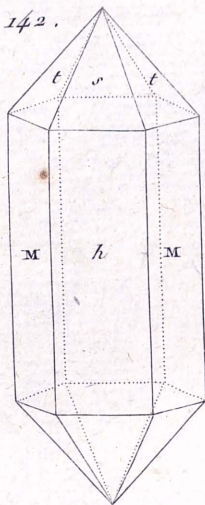

Fig. 143.

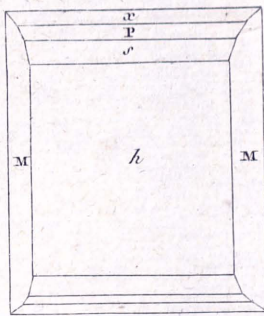
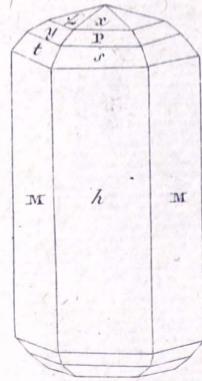

Fig. 144.



SOUDE MURLATÉE

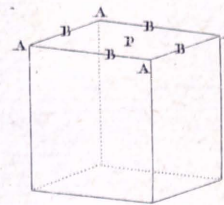

Fig. 145.

Fig. 146.

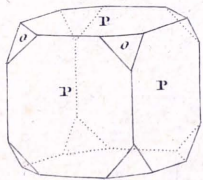
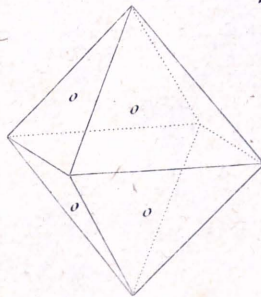

Fig. 147.



SOUDE BORATÉE

Fig. 148.

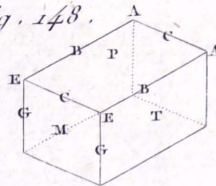

Fig. 149.

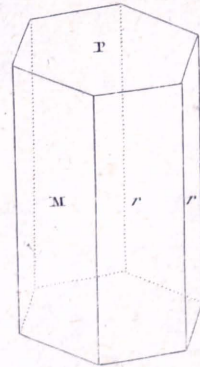

Fig. 150.

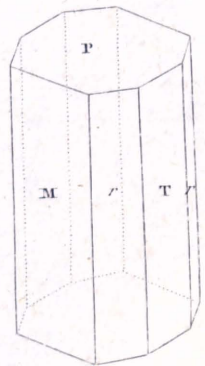

PLATE I



Suite de la SOUDE BORATÉE Fig. 152.

Fig. 153.

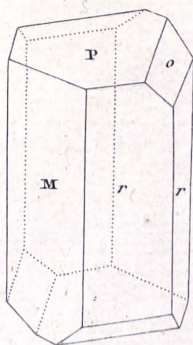
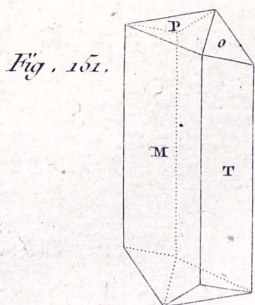
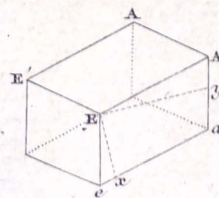

Fig. 154.



SOUDE CARBONATÉE

AMMONIAQUE MURIATÉE

Fig. 155.

Fig. 157.

Fig. 158.

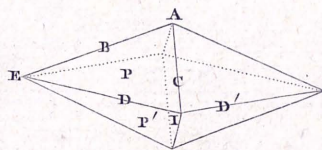
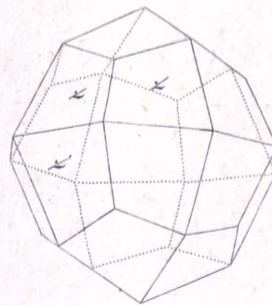
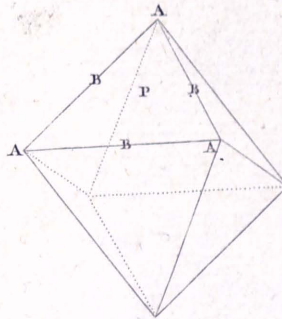

Fig. 156.



ALUMINE SULFATÉE ALKALINE

Fig. 159.

Fig. 160.

Fig. 161.

Fig. 162.

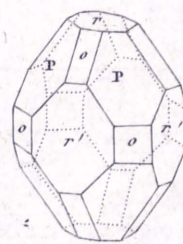
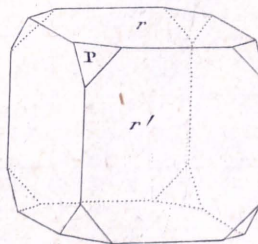
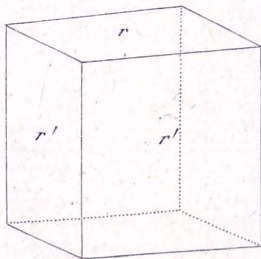
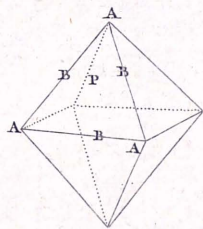

17

THE HISTORY OF THE

17

QUARTZ

Fig. 1.

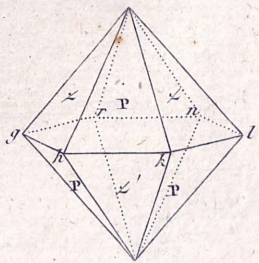

Fig. 2.

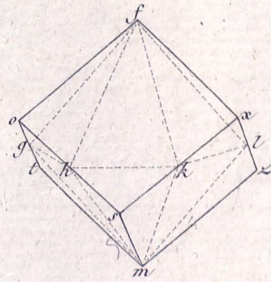

Fig. 3.

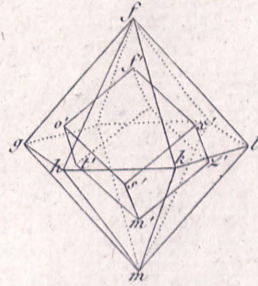

Fig. 4.

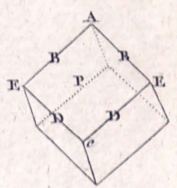

Fig. 5.

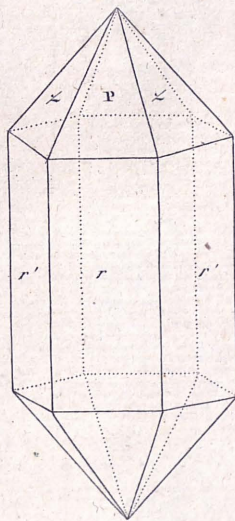

Fig. 6.

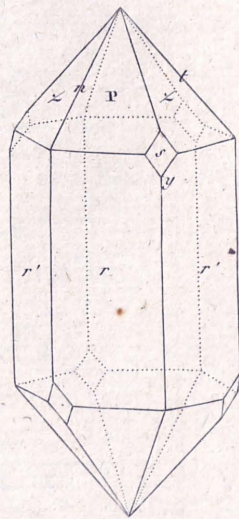

Fig. 7.

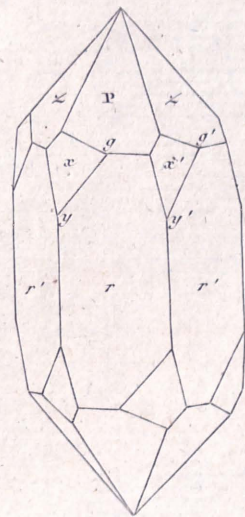
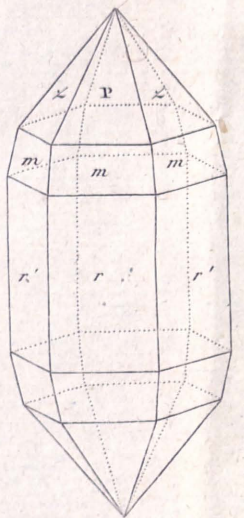
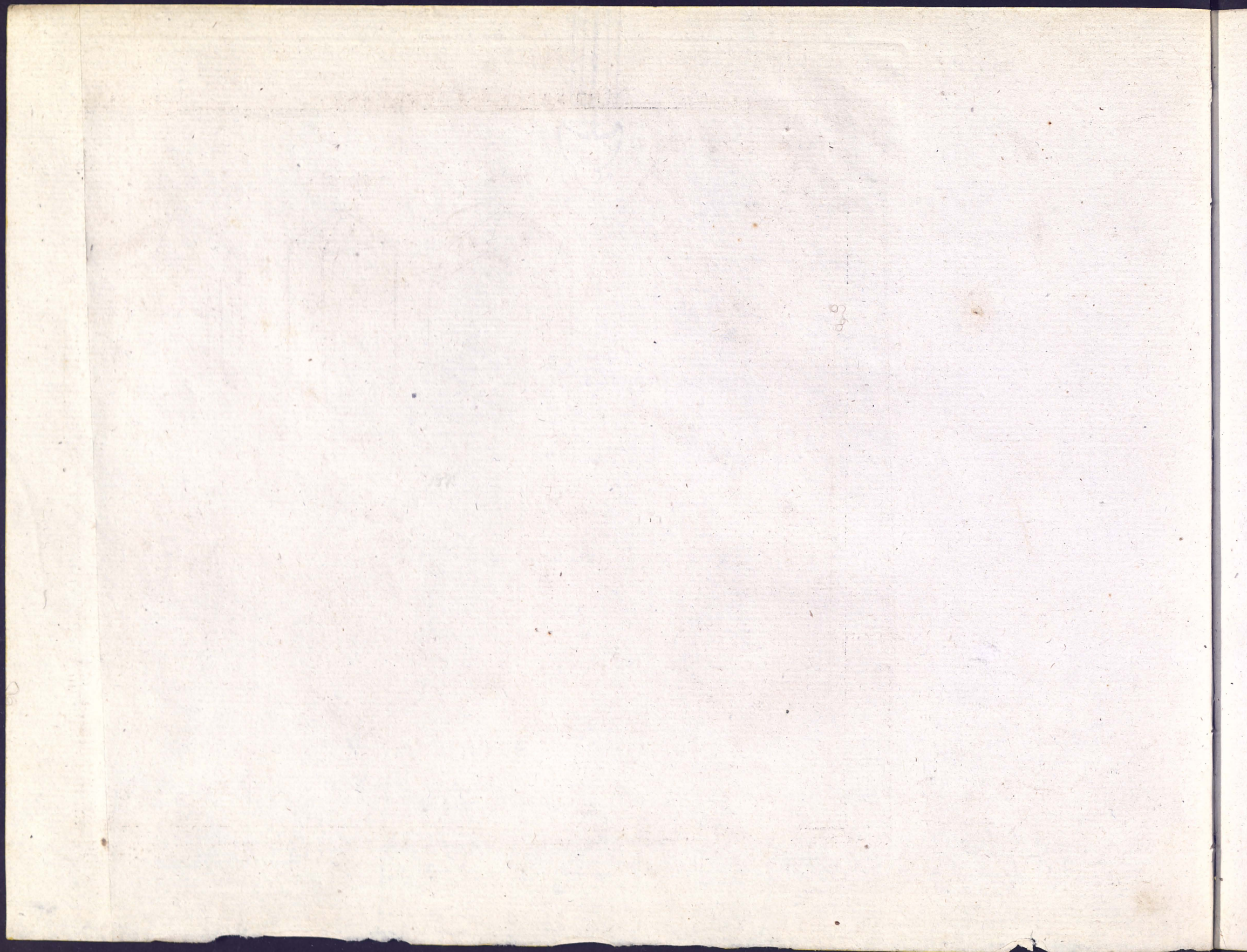

Fig. 8.





ZIRCON

Fig. 9.

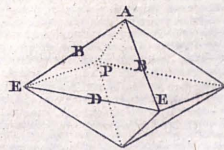

Fig. 10.

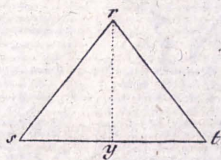

Fig. 12.

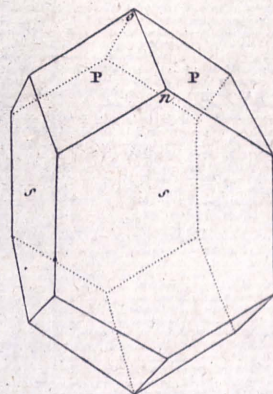

Fig. 13.

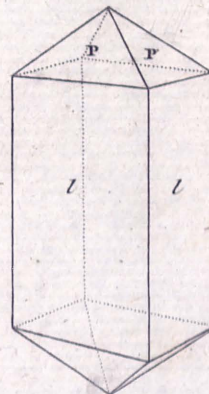

Fig. 14.

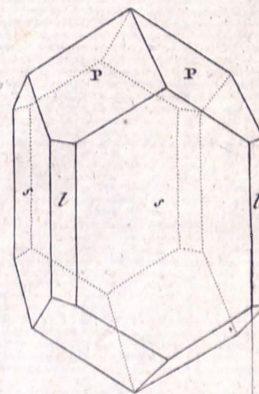

Fig. 11.

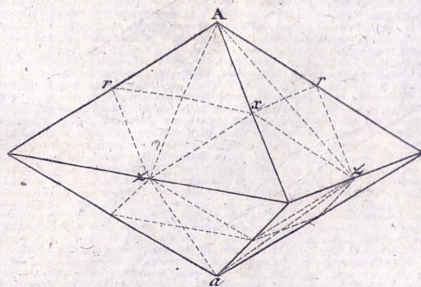

Fig. 15.

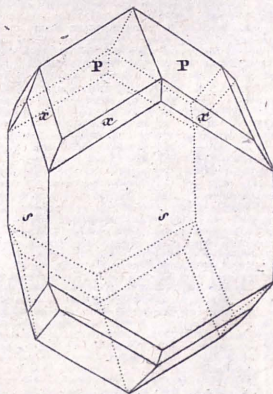

Fig. 16.

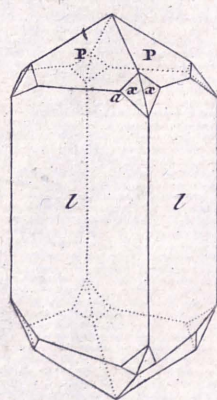

Fig. 17.

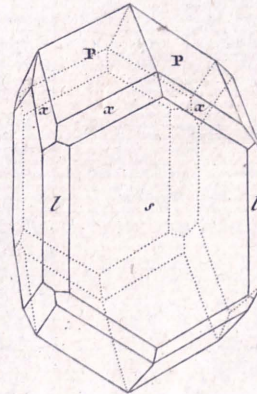
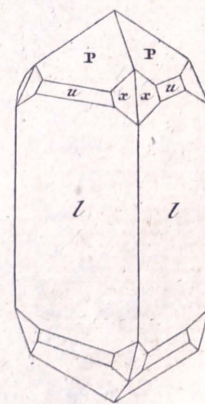
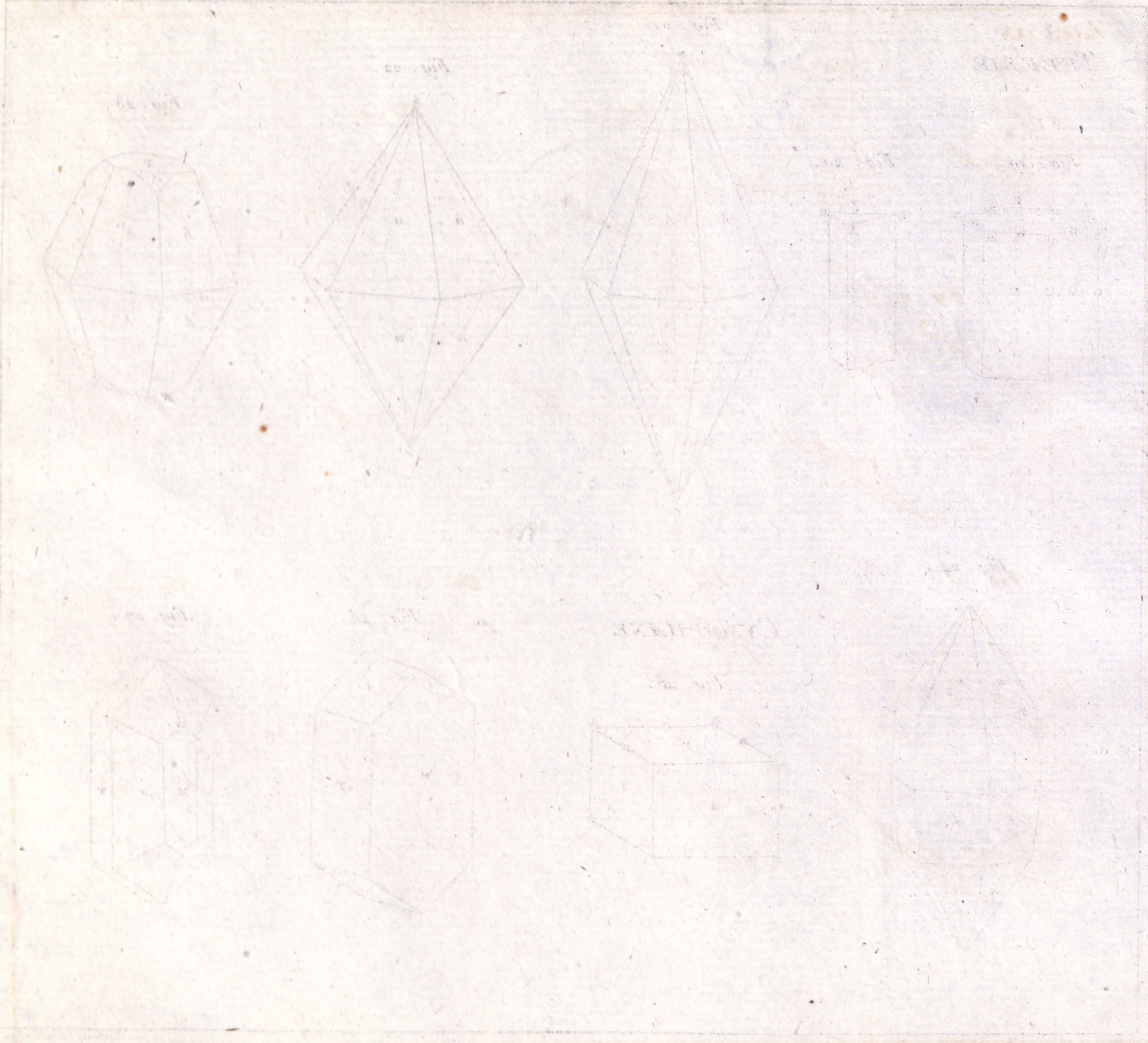

Fig. 18.





TELESIE

Fig. 19.

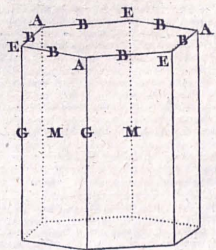

Fig. 20.

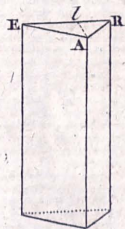

Fig. 21.

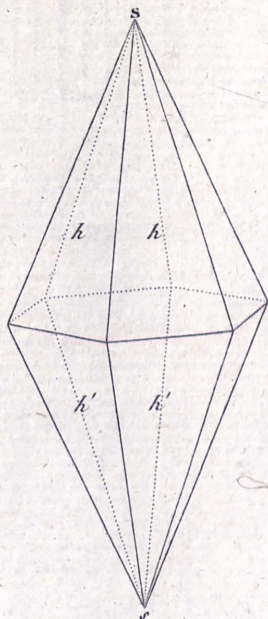

Fig. 22.

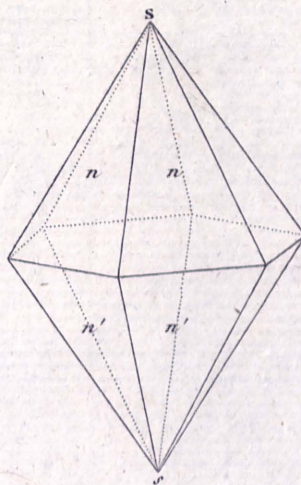

Fig. 23.

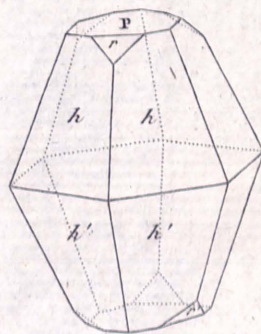
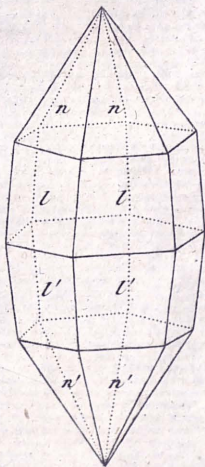

Fig. 24.



CYMOPHANE

Fig. 25.

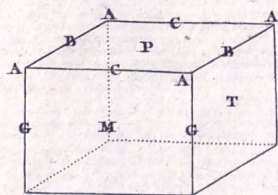

Fig. 26.

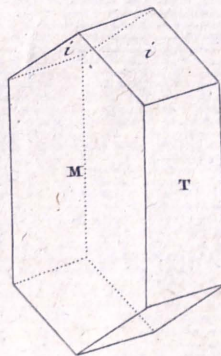
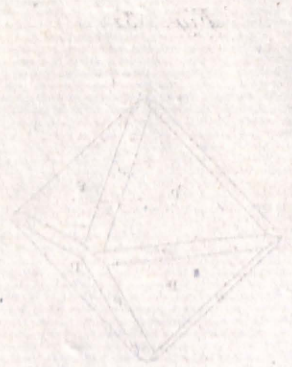

Fig. 27.



SPINALE

DE FIGURIS QUADRANGULIS



Suite de la CYMOPHANE

SPINELLE

Fig. 28.

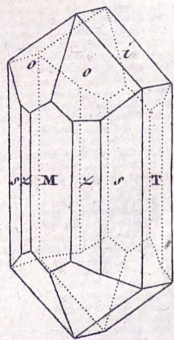

Fig. 29.

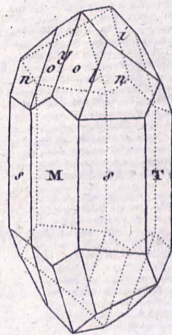

Fig. 30.

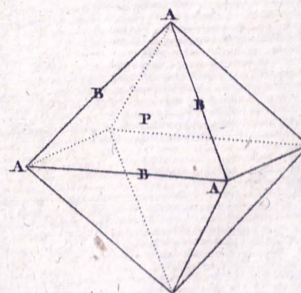

Fig. 31.

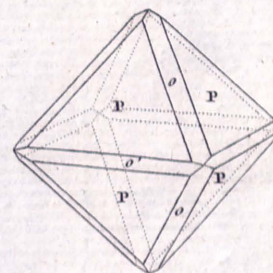

Fig. 32.

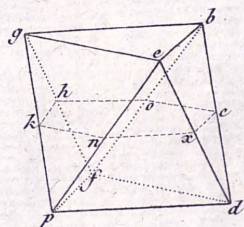

Fig. 33.

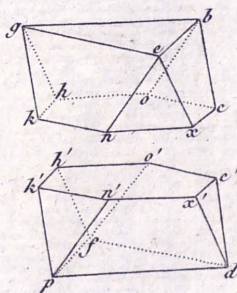

Fig. 34.

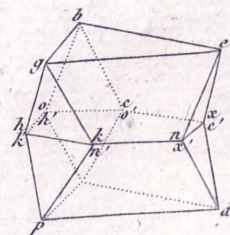

Fig. 35.

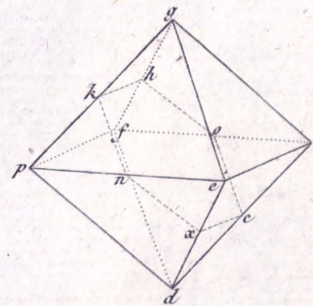
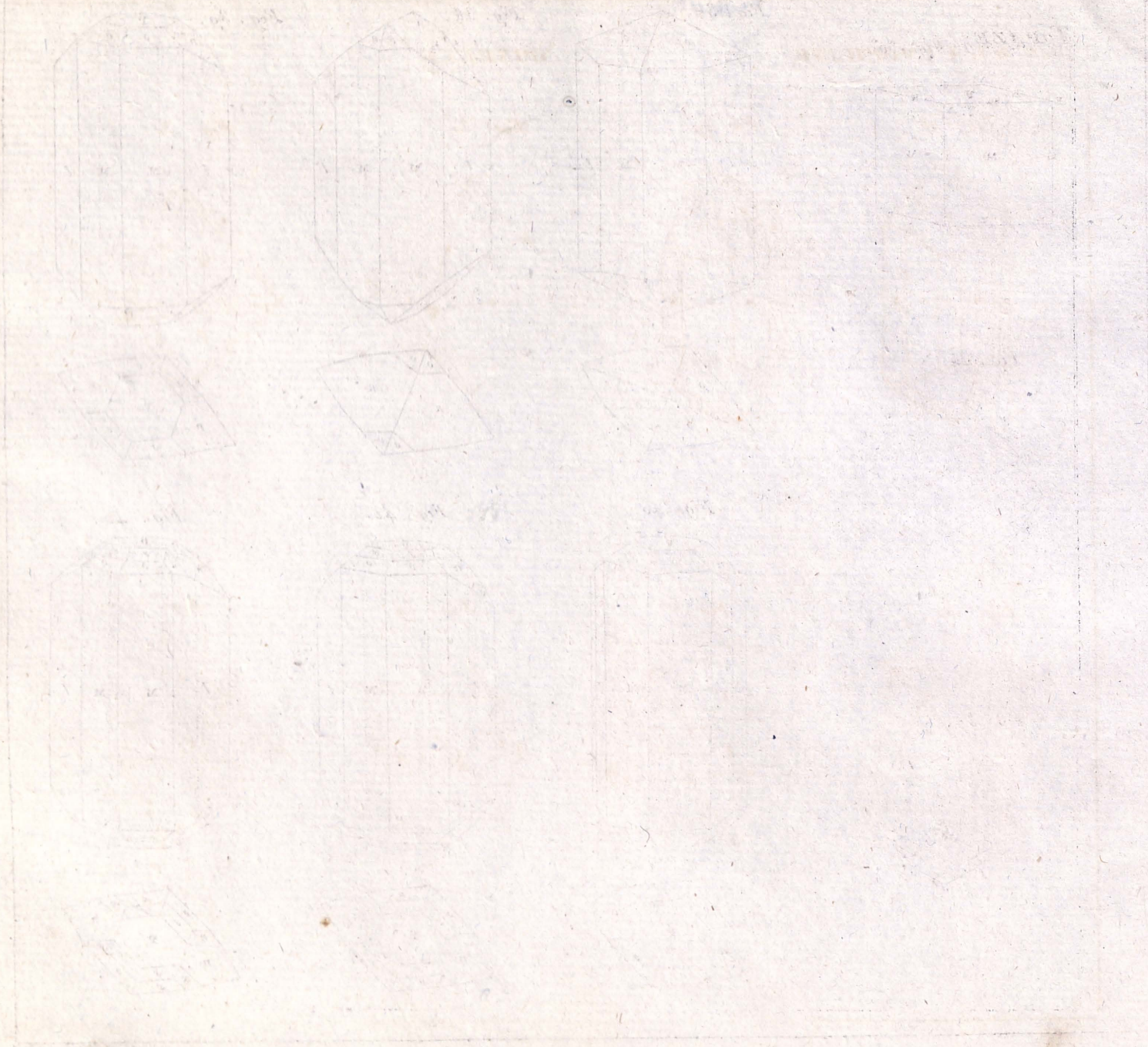

PLATE I
PROJECTIONS OF THE CUBE



TOPAZE Fig. 36.

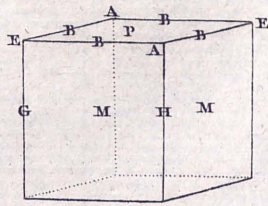

Fig. 37.

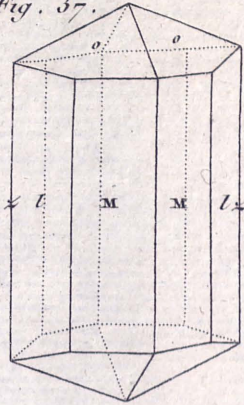

Fig. 38.

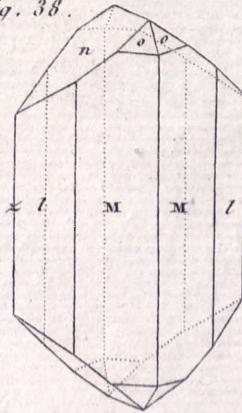

Fig. 39.

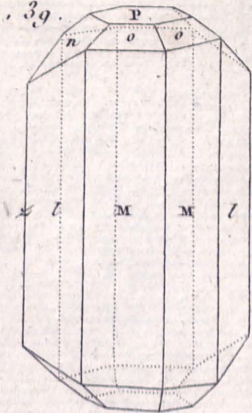

Fig. 40. A

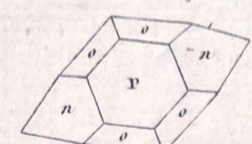
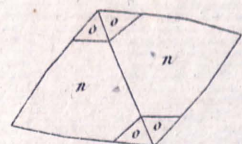
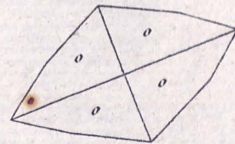
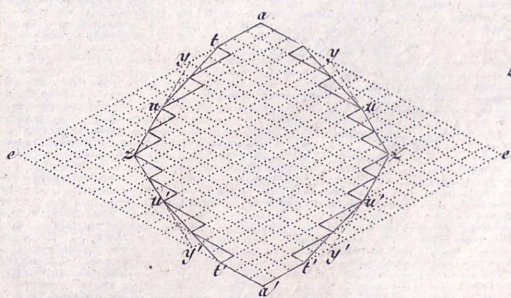

Fig. 40.

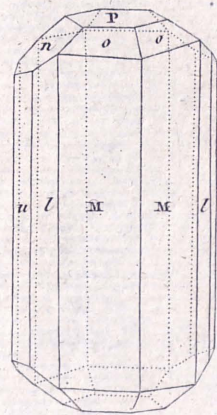

Fig. 41.

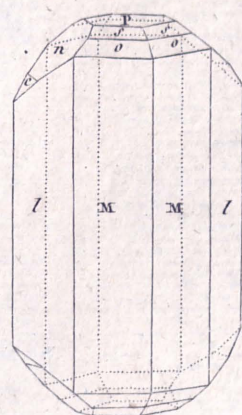
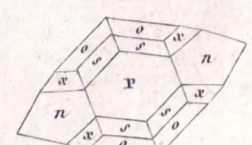
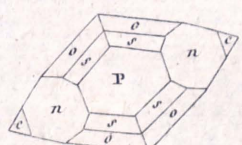
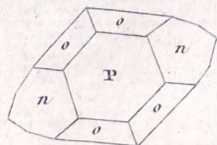
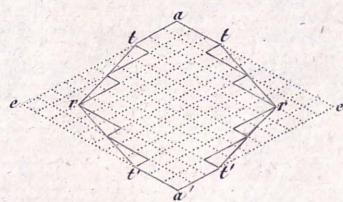

Fig. 42.

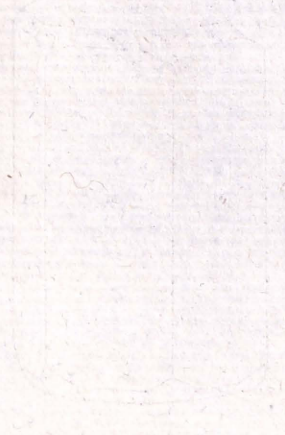
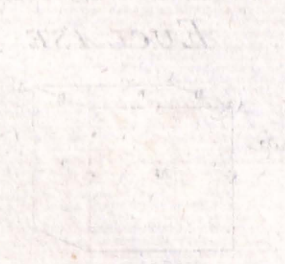
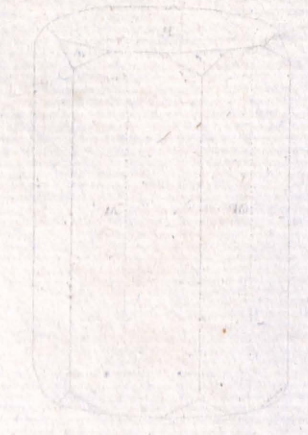

Fig. 37. A



PLATE

THE ARCHITECTURE OF THE



EMERAUDE

Fig. 43.

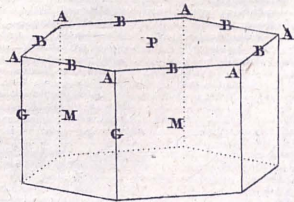

Fig. 45.

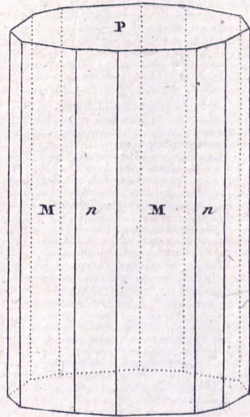

Fig. 46.

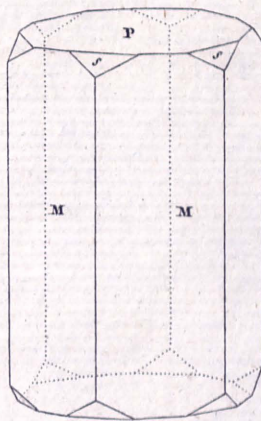

Fig. 47.

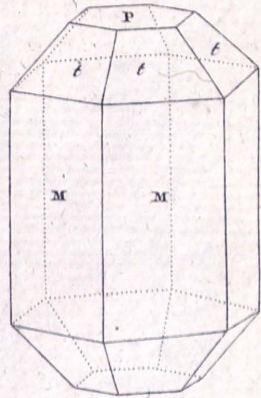

Fig. 44.



EUCLASE

Fig. 51.

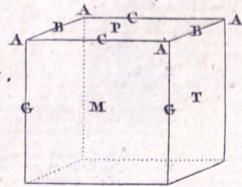

Fig. 48.

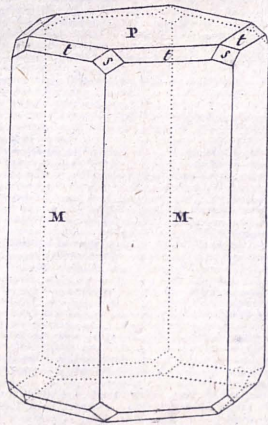

Fig. 49.

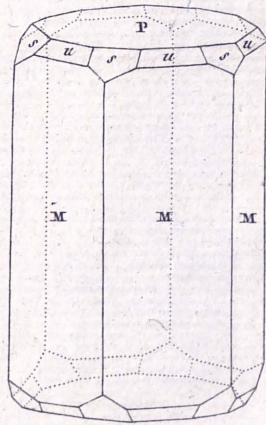

Fig. 50.

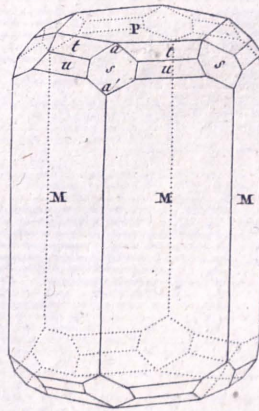
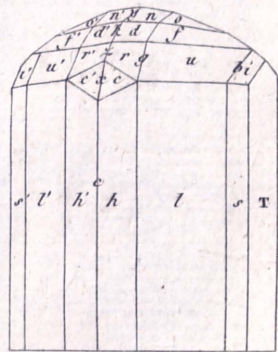
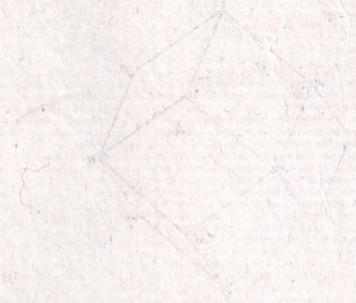

Fig. 52.





GRENAT

Fig. 53.

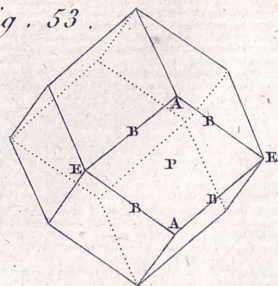

Fig. 54.

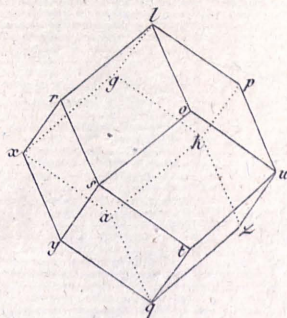

Fig. 55.

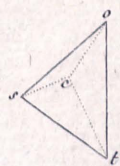

Fig. 56.

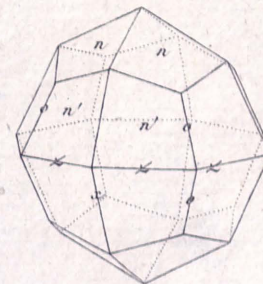

Fig. 57.

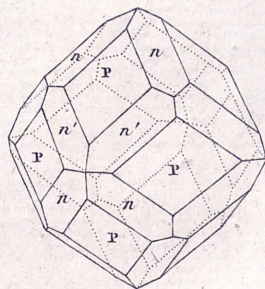

Fig. 58.

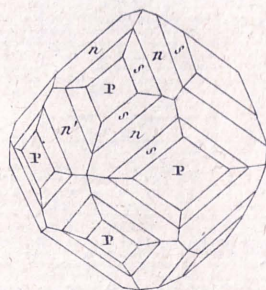

Fig. 59.

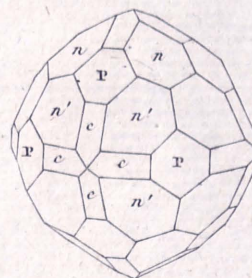
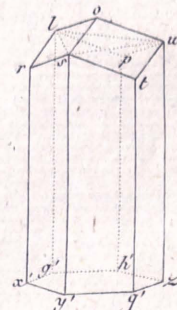

Fig. 60.



AMPHIGENE

Fig. 61.

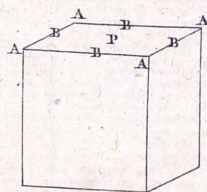

Fig. 62.

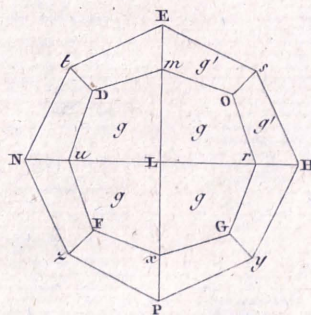

Fig. 63.

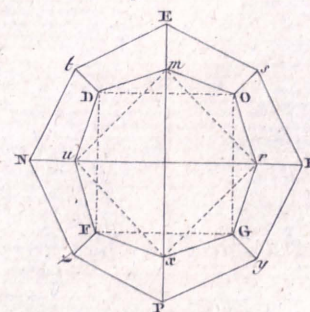

PLATE VI

THE TEMPLE OF SATURN

FIGURE 1



FIGURE 2



Suite de L'AMPHIGENE

Fig. 64.

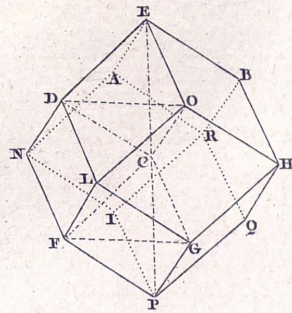

Fig. 65.

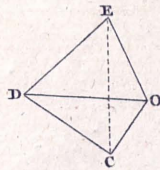

Fig. 66.

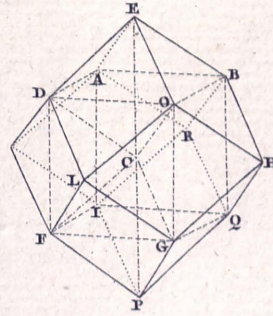

Fig. 67.

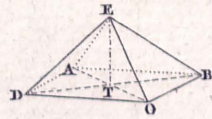
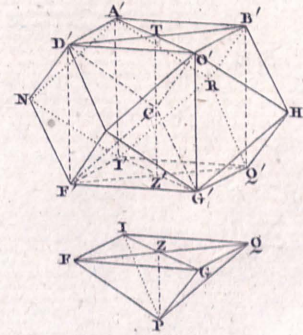
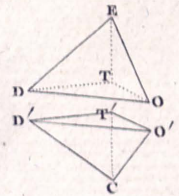

Fig. 68.



IDOCRASE

Fig. 69.

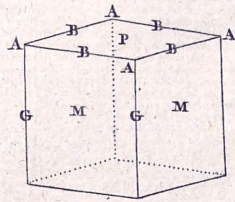

Fig. 70.

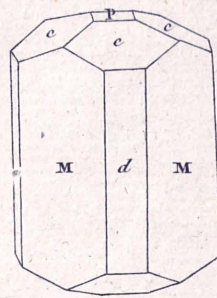

Fig. 72.

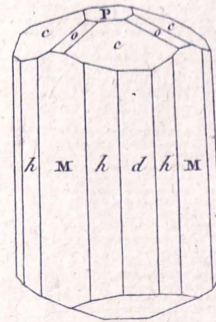

Fig. 74.

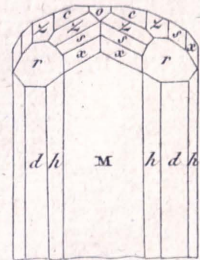

Fig. 71.

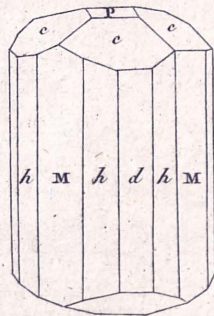

Fig. 73.

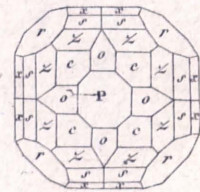
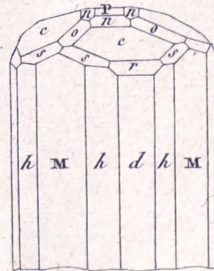

Fig. 74

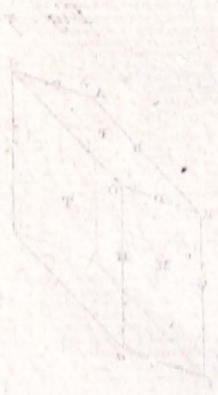

Fig. 75



Fig. 76



Fig. 77



Fig. 78



Fig. 79



Fig. 80



Fig. 81



MEIONITE

Fig. 75.

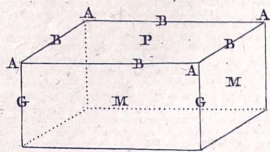

Fig. 76.

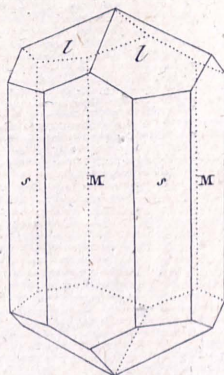
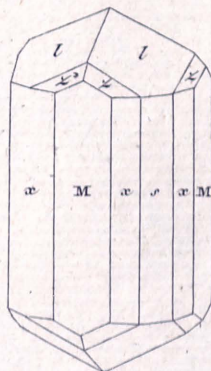

Fig. 77.



FELD-SPATH

Fig. 78.

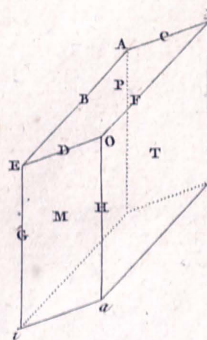

Fig. 79.

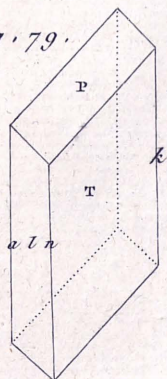

Fig. 82.

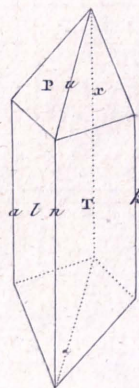

Fig. 83.

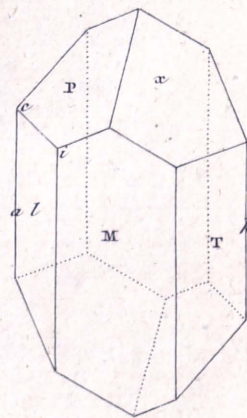

Fig. 80.

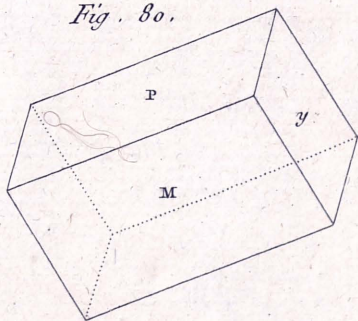
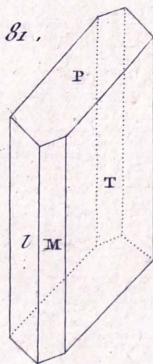
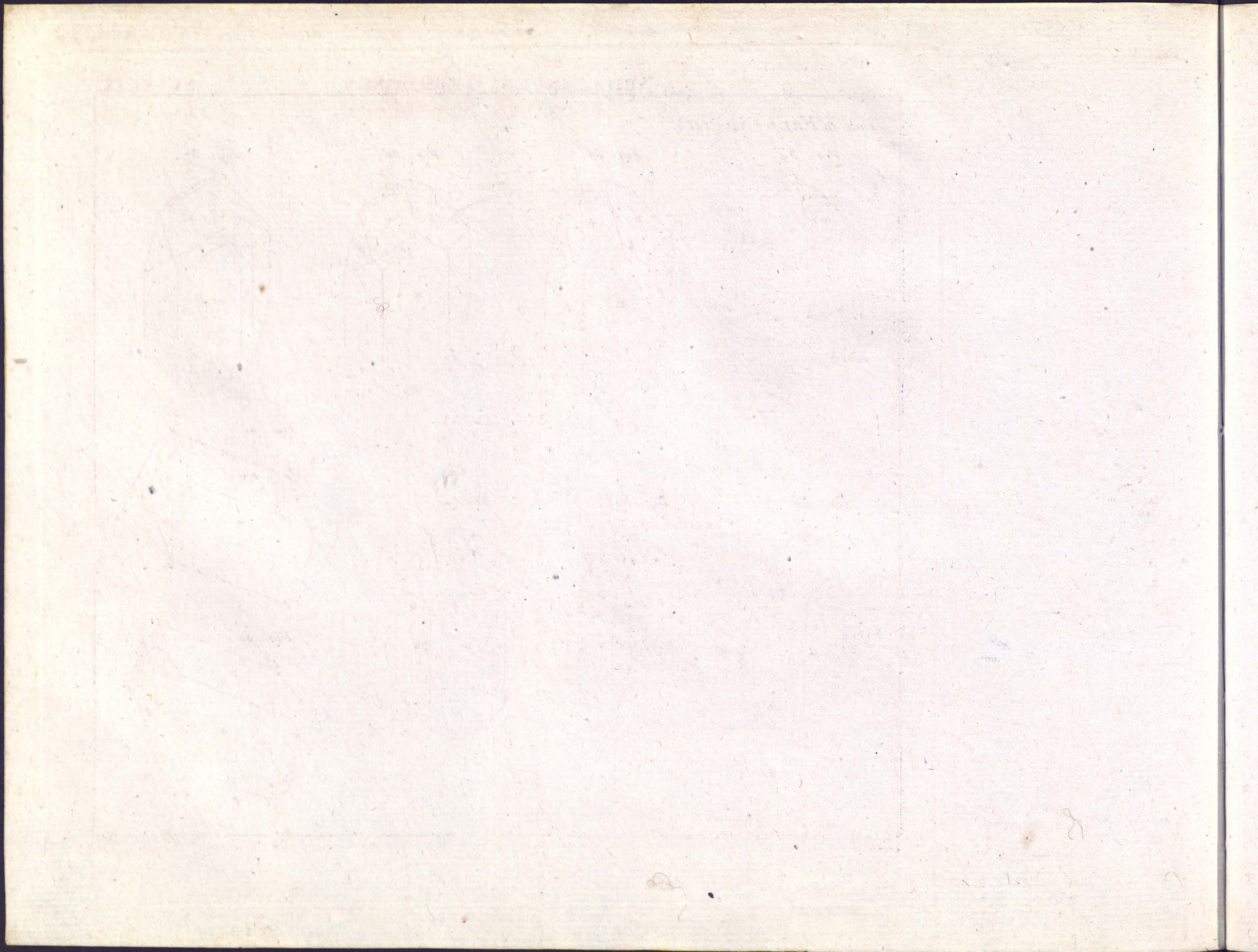

Fig. 81.





Suite du FELD-SPATH.

Fig. 84.

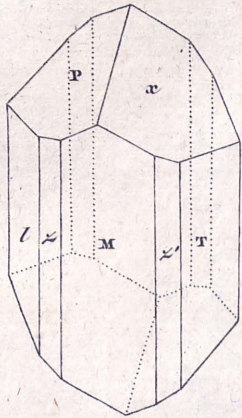

Fig. 85.

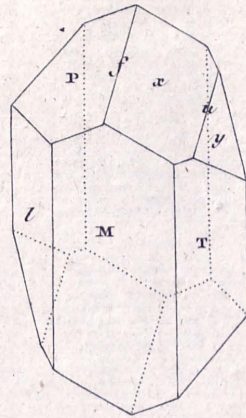

Fig. 86.

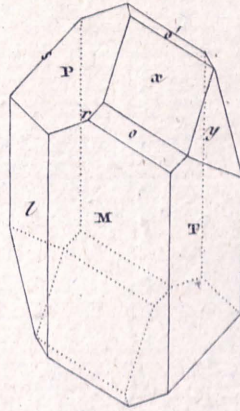

Fig. 87.

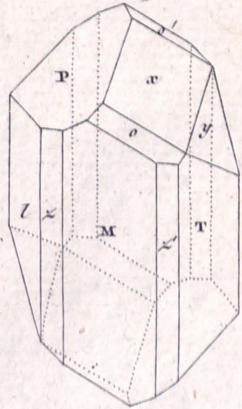

Fig. 88.

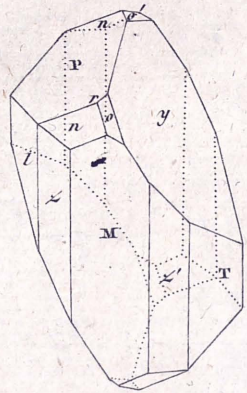

Fig. 89.

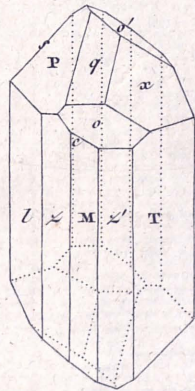

Fig. 90.

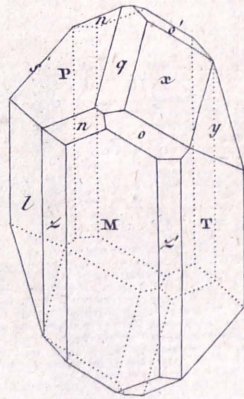

Fig. 91.

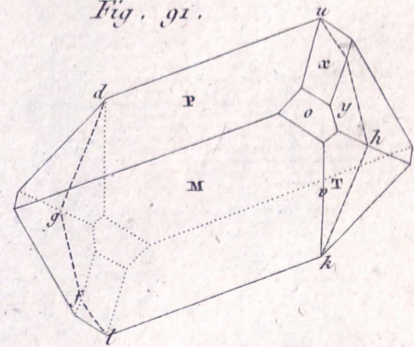
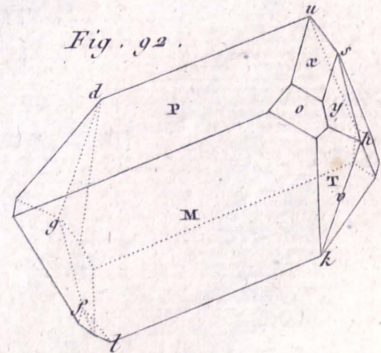
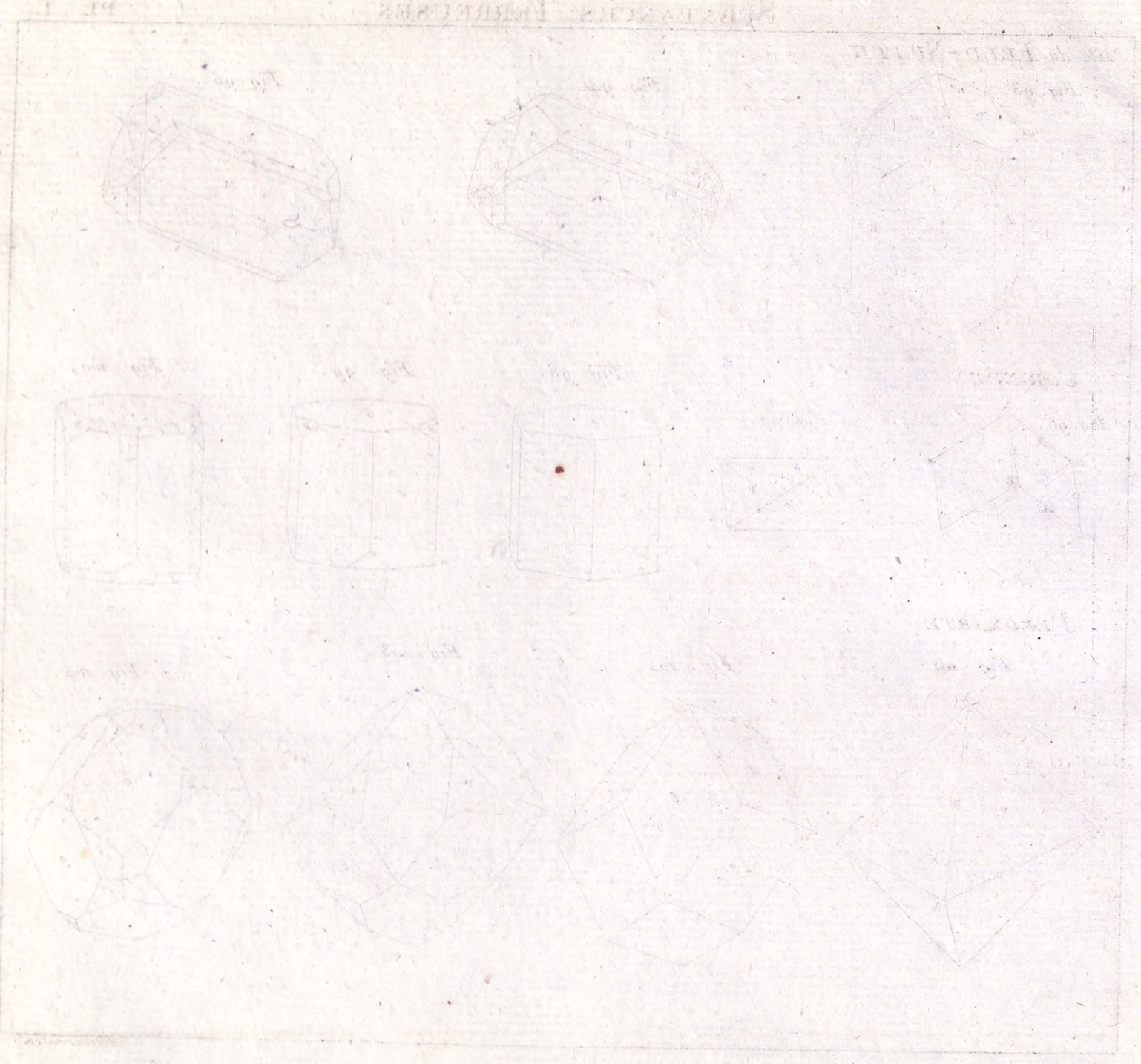

Fig. 92.





Suite du FELD-SPATH

Fig. 93.

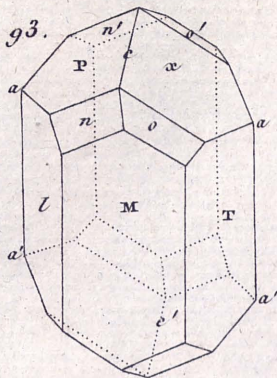

Fig. 94.

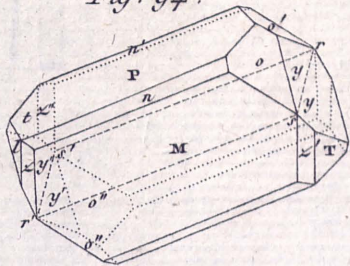
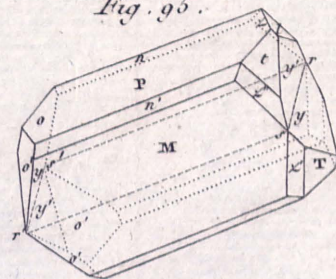

Fig. 95.



CORINDON

Fig. 96.

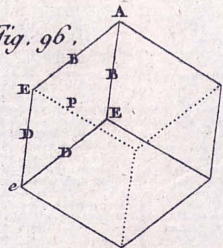

Fig. 97.

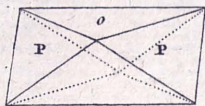

Fig. 98.

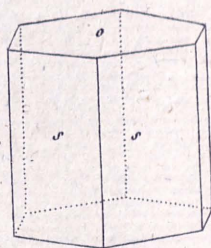

Fig. 99.

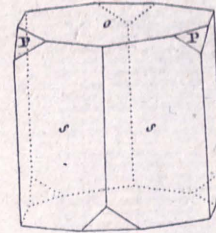
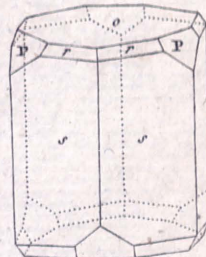

Fig. 100.



PLEONASTE

Fig. 101.

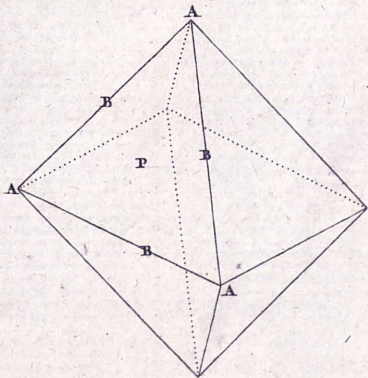

Fig. 102.

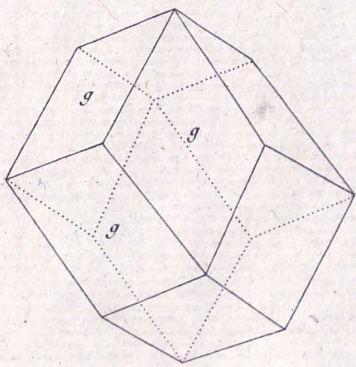

Fig. 103.

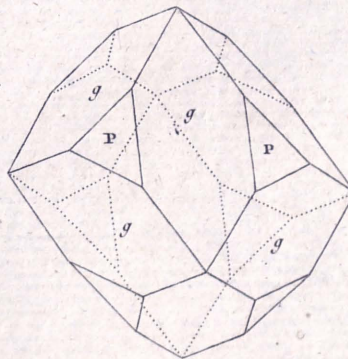
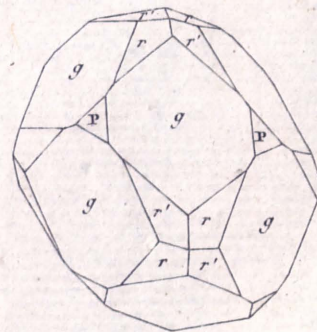
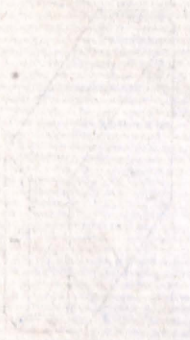

Fig. 104.





8

9

AXINITE

Fig. 105.

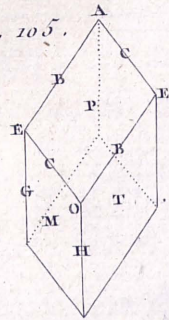

Fig. 106.

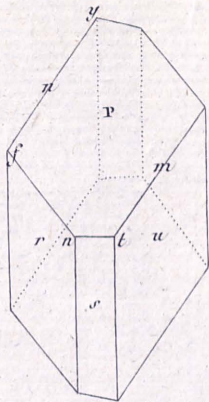

Fig. 107.

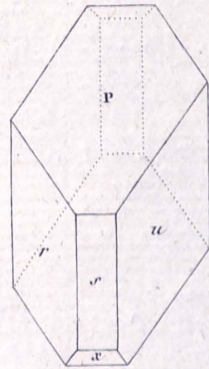

Fig. 108.

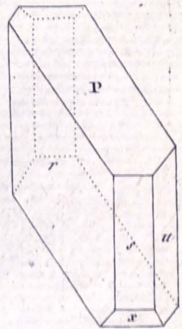

Fig. 109.

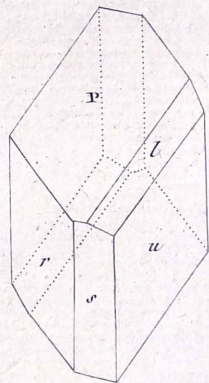

Fig. 110.

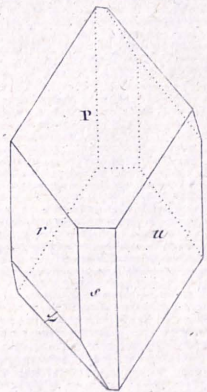

Fig. 111.

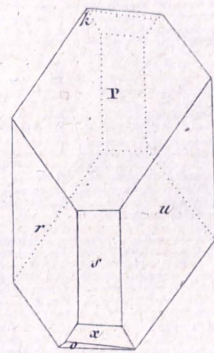
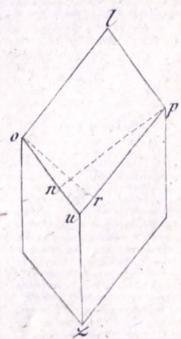
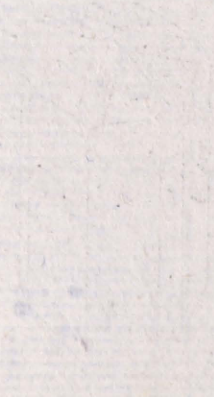
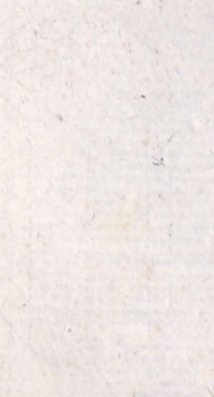
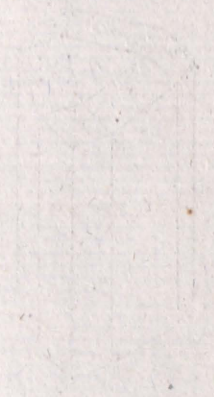
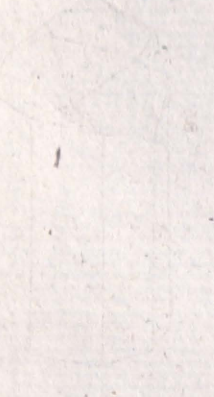
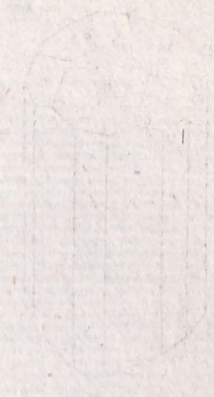
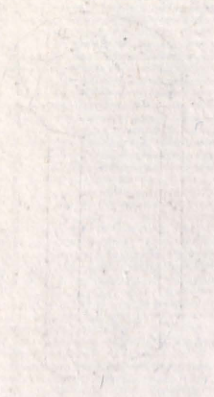

Fig. 112.



1711

1711



TOURMALINE

Fig. 113.

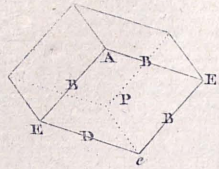

Fig. 114.

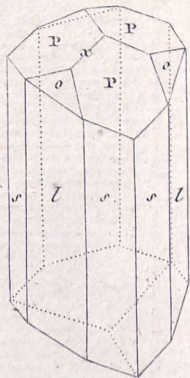

Fig. 115.

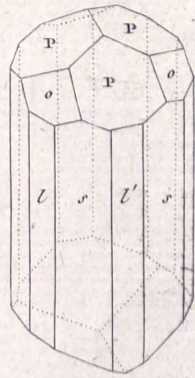

Fig. 116.

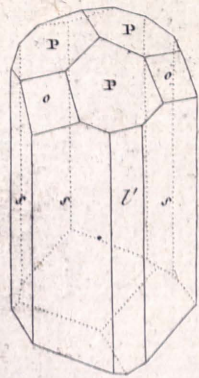

Fig. 117.

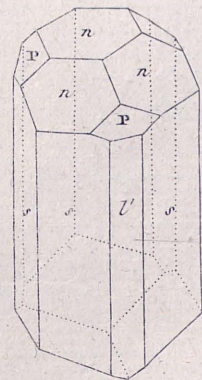

Fig. 118.

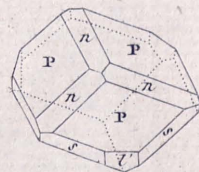

Fig. 119.

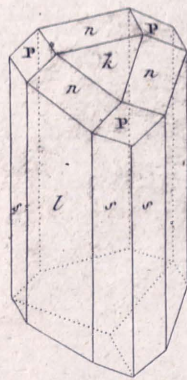

Fig. 120.

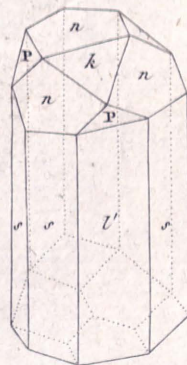

Fig. 121.

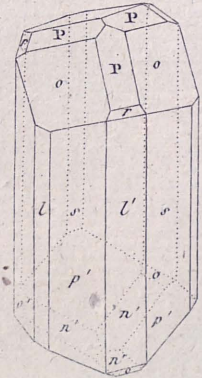

Fig. 122.

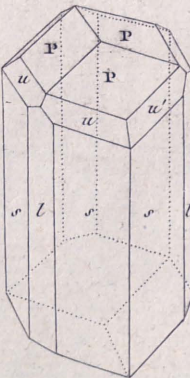

Fig. 123.

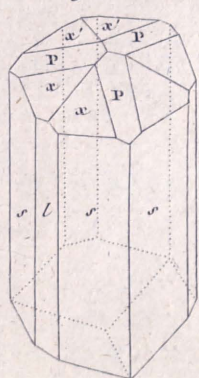
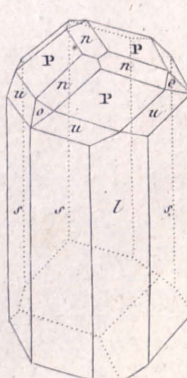
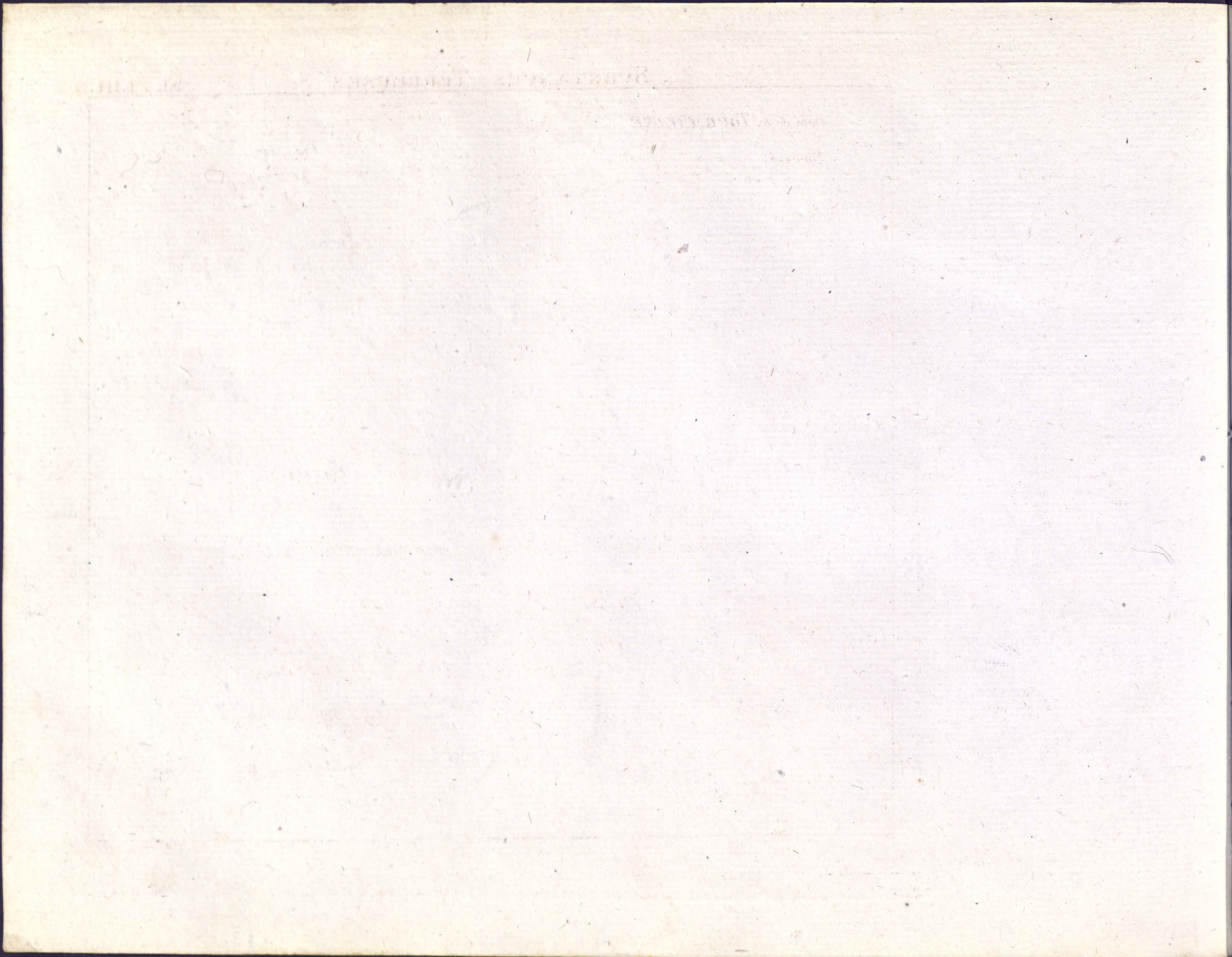

Fig. 124.





Suite de la TOURMALINE

Fig. 125.

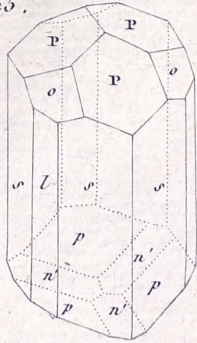

Fig. 126.

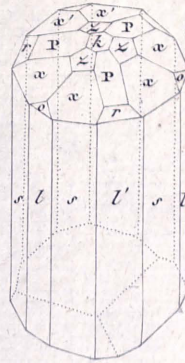

Fig. 127.

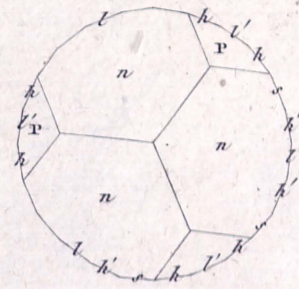

Fig. 128.

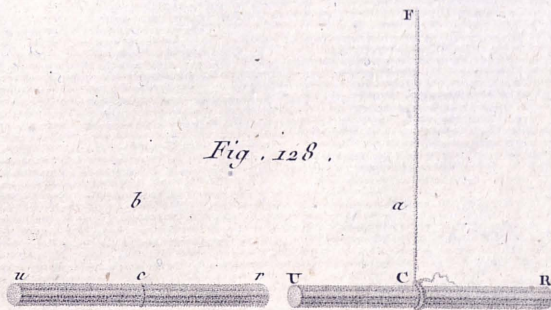

Fig. 129.

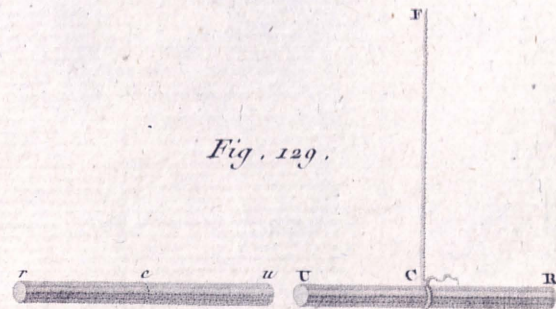

Fig. 130.

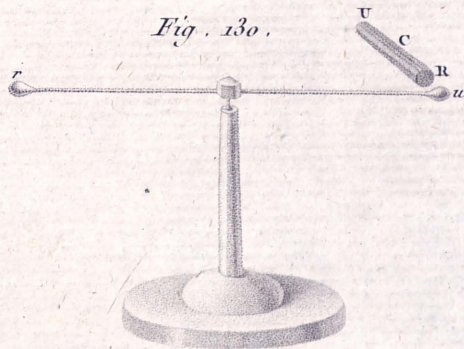
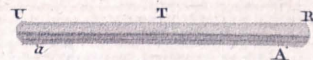

Fig. 131.



VII 23

THE UNIVERSITY OF CHICAGO

1891

1891

1891

1891

1891

1891

1891

1891

1891

1891

AMPHIBOLE

Fig. 132.

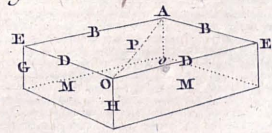

Fig. 133.



Fig. 134.

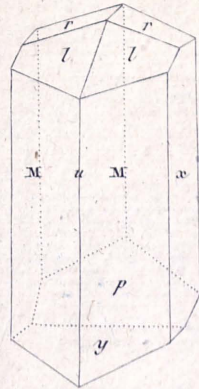

Fig. 135.

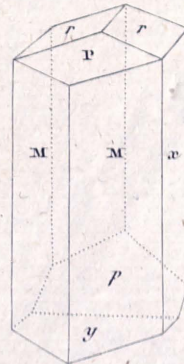

Fig. 136.

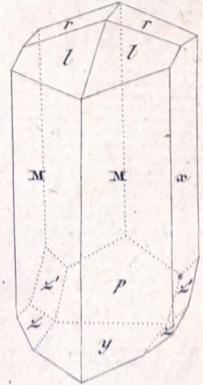
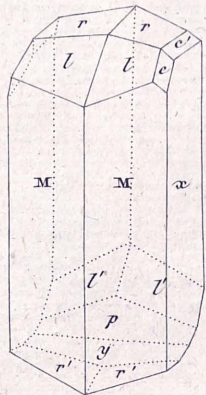

Fig. 137.



PYROXENE

Fig. 138.

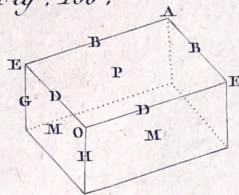

Fig. 139.

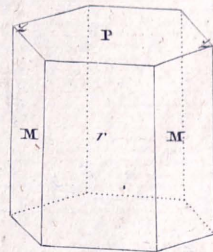

Fig. 140.

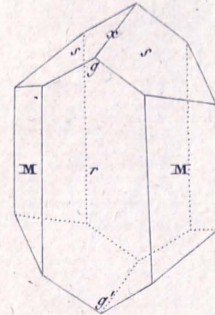

Fig. 141.

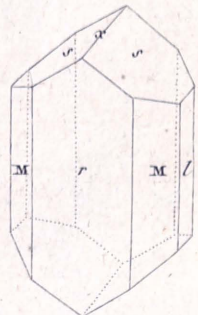

Fig. 142.

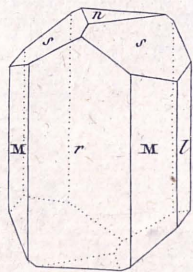

Fig. 143.

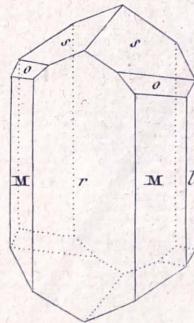

Fig. 144.

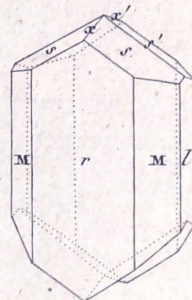
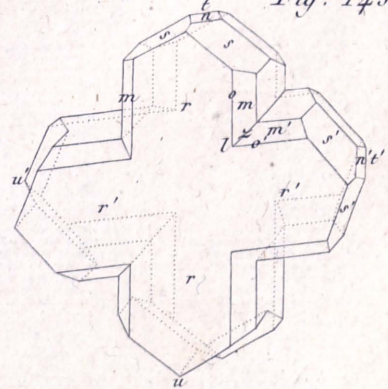

Fig. 145.



9

NO. 100

8

10

11

Fig. 147.

Fig. 148.

Fig. 149.

STAUROTIDE

Fig. 146.

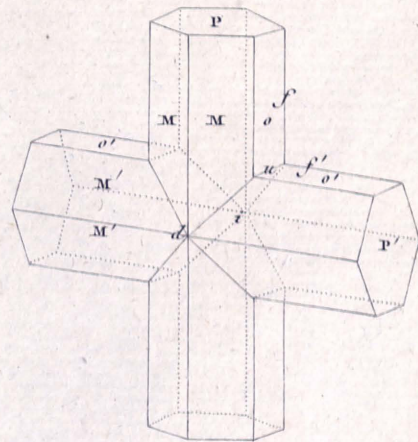
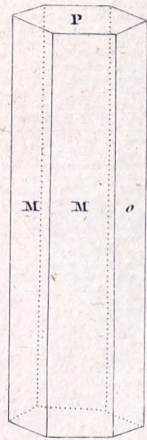
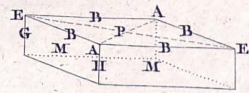
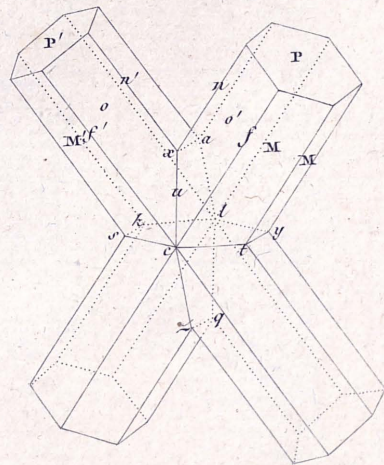

Fig. 150.



EPIDOTE

Fig. 151.

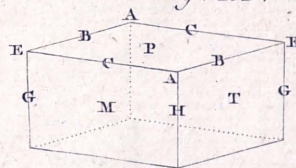

Fig. 152.

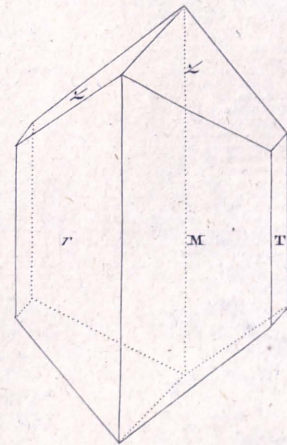
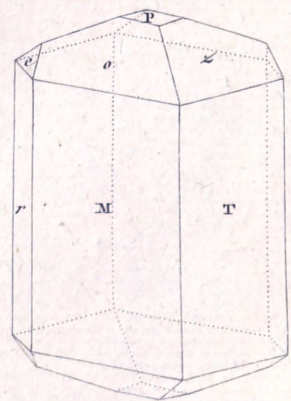
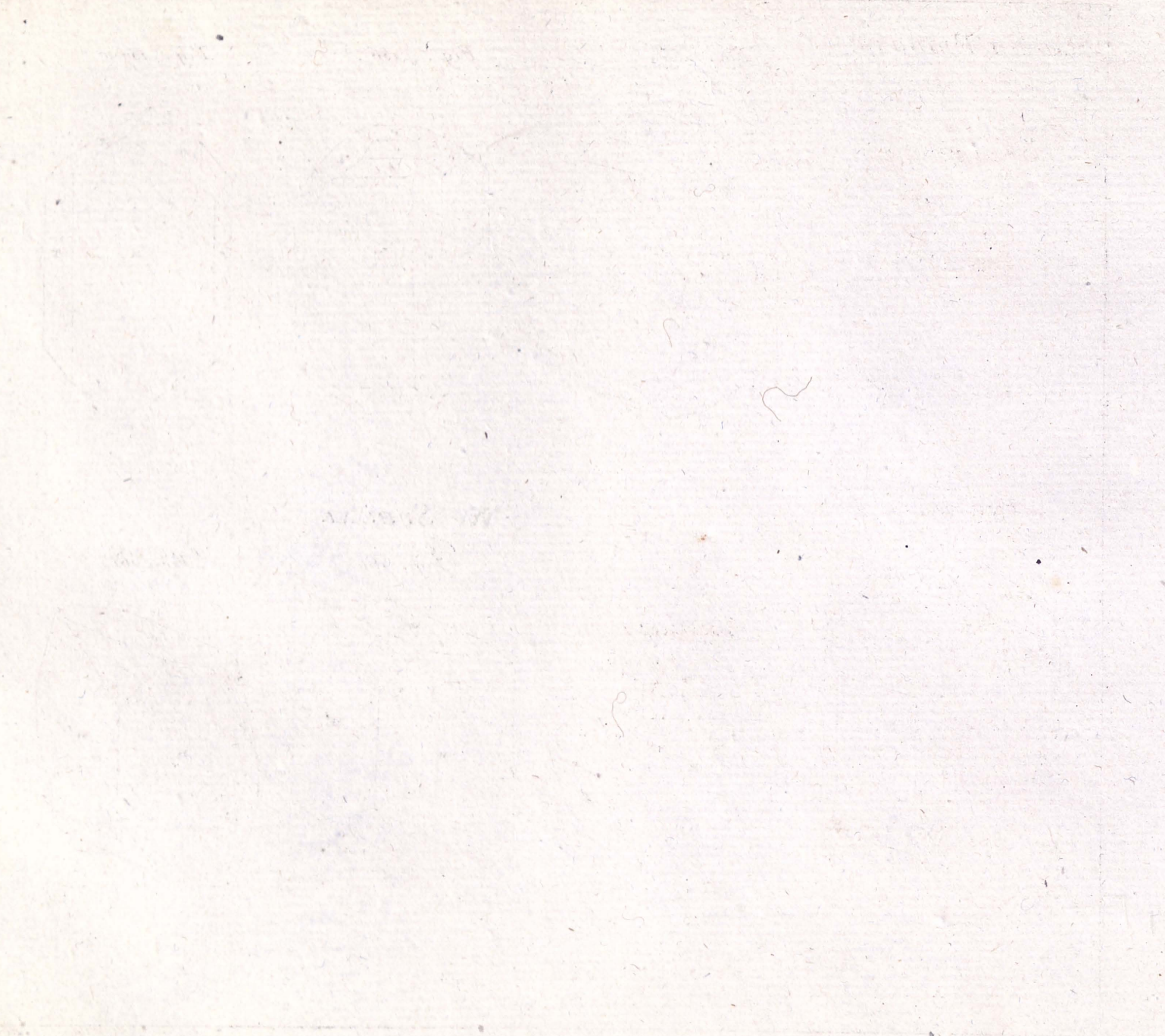

Fig. 153.



171

171



171

Suite de L'EPIDOTE

Fig. 154.

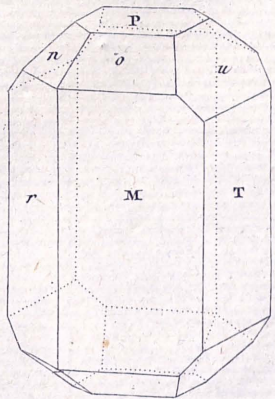

Fig. 155.

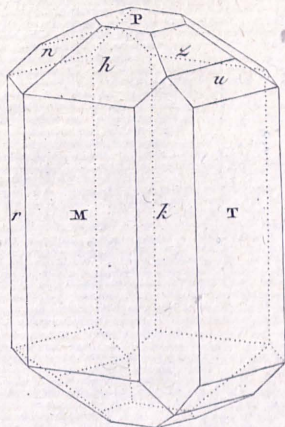

Fig. 156.

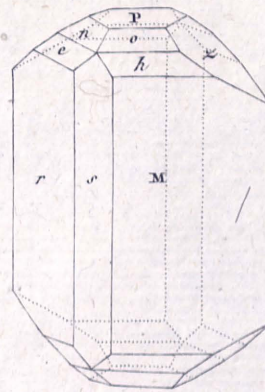

Fig. 157.

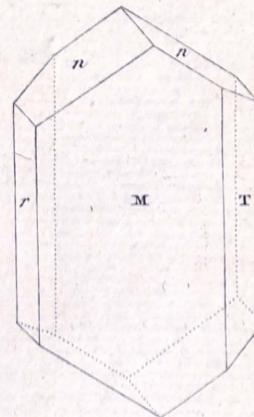
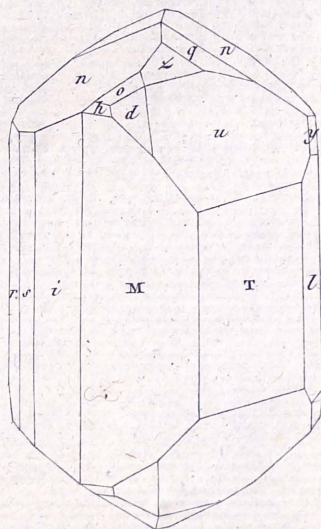

Fig. 158.



SPHENE

Fig. 160.

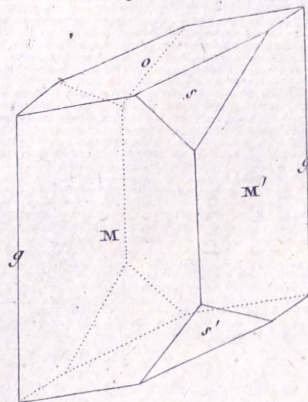

Fig. 161.

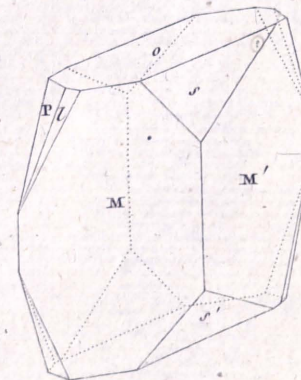
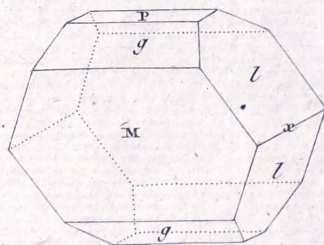
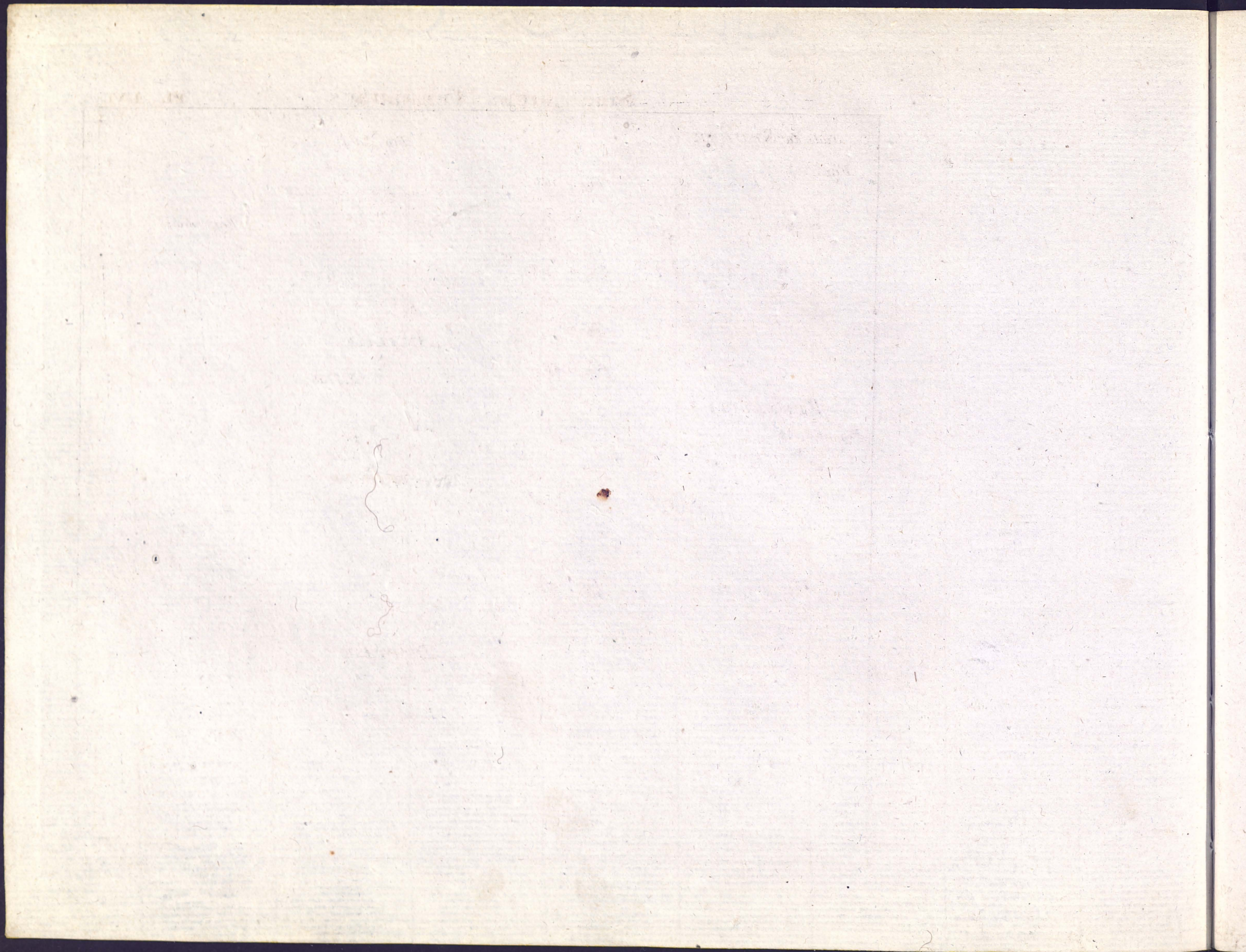

Fig. 159.





Suite du SPHENE

Fig. 162.

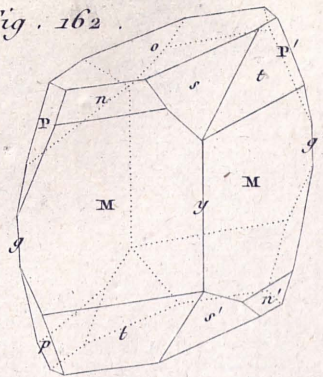

Fig. 163.

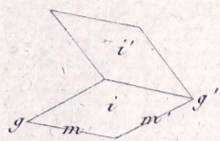

Fig. 164.

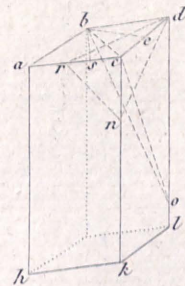
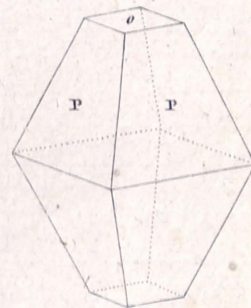

Fig. 168.



WERNERITE

Fig. 165.

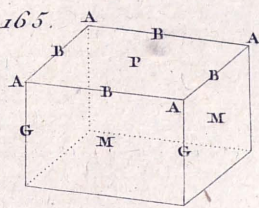
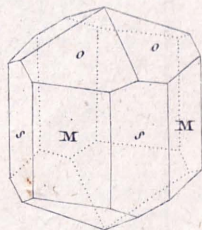

Fig. 166.



ANATASE

Fig. 167.

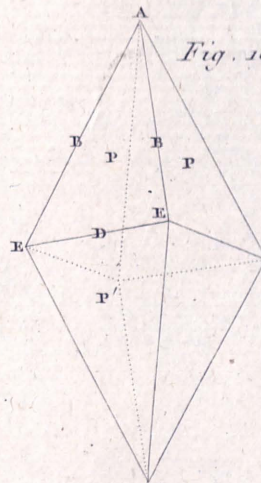

Fig. 172.

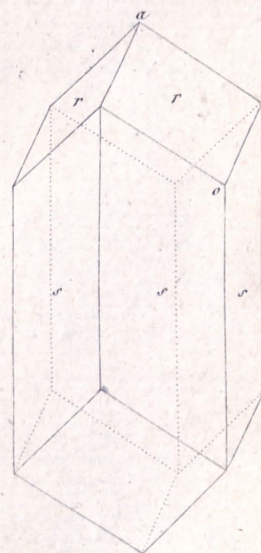

Fig. 169.

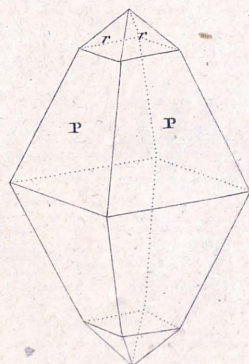
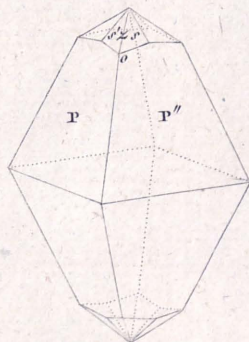
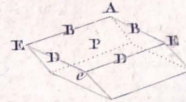

Fig. 170.



DIOPHASE

Fig. 171.



THE HISTORY OF THE UNITED STATES OF AMERICA

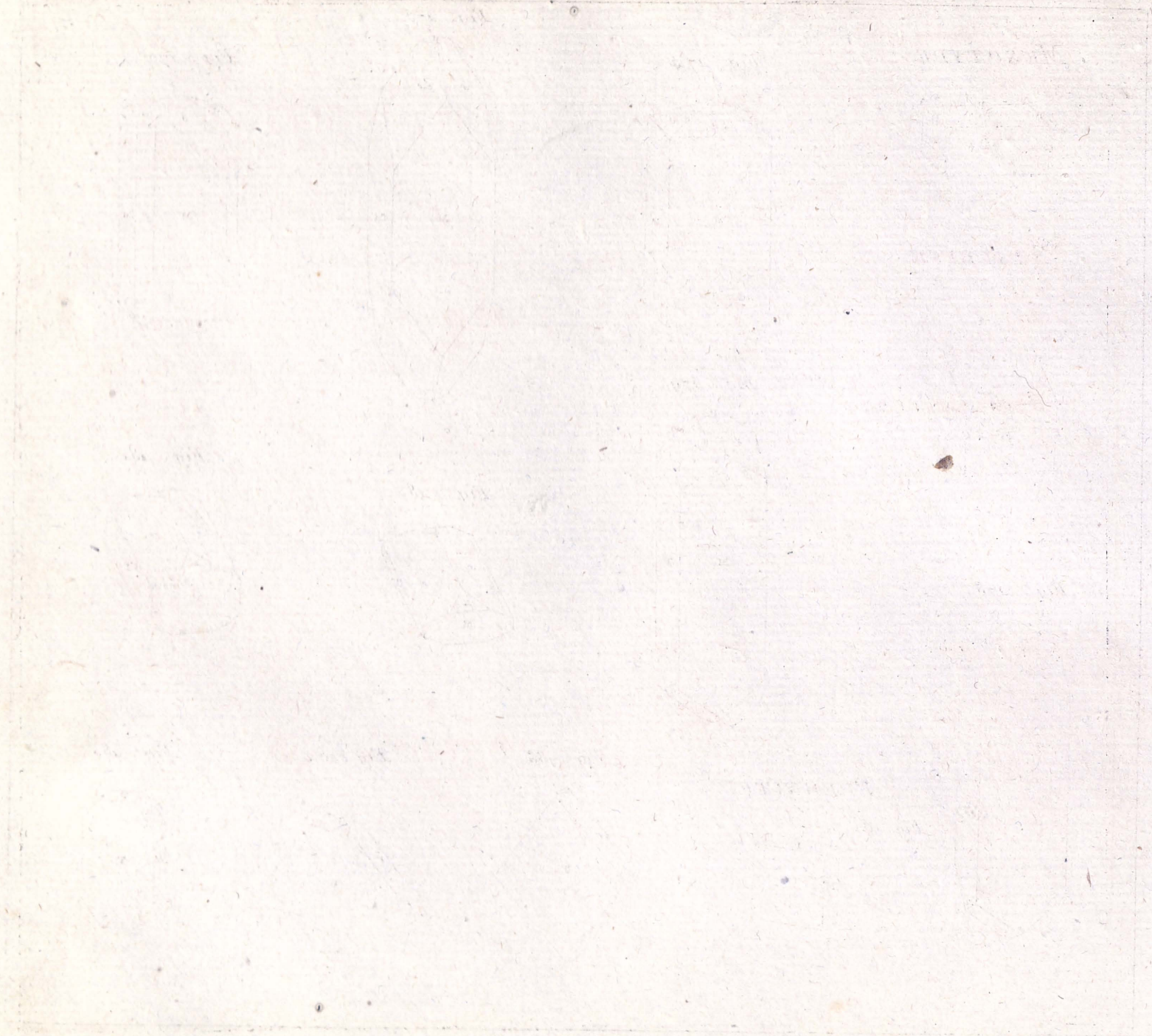

MESOTYPE

Fig. 173.

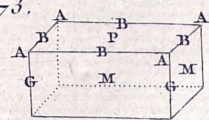

STILBITE

Fig. 177.

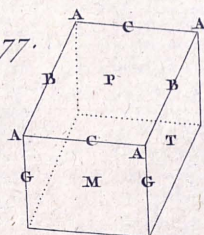
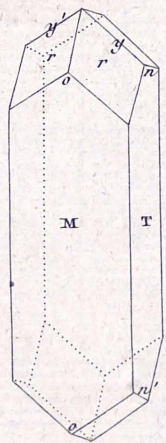

Fig. 178.



PREHNITE

Fig. 182.

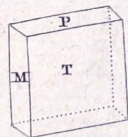

Fig. 174.

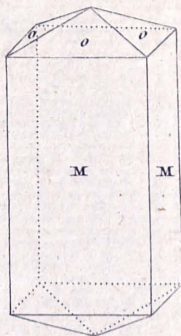

Fig. 179.

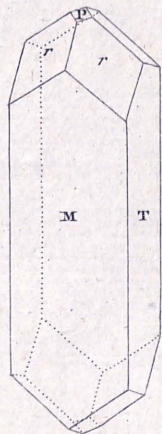

Fig. 175.

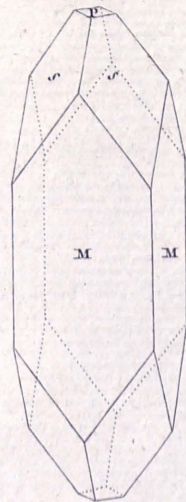

Fig. 176.

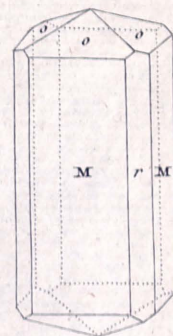

Fig. 180.

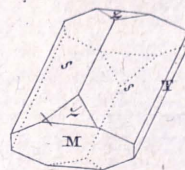

Fig. 181.

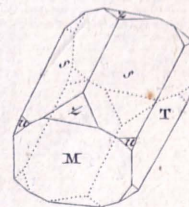

Fig. 183.

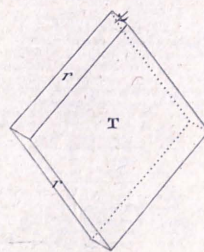

Fig. 184.

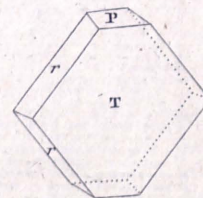
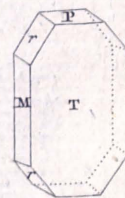
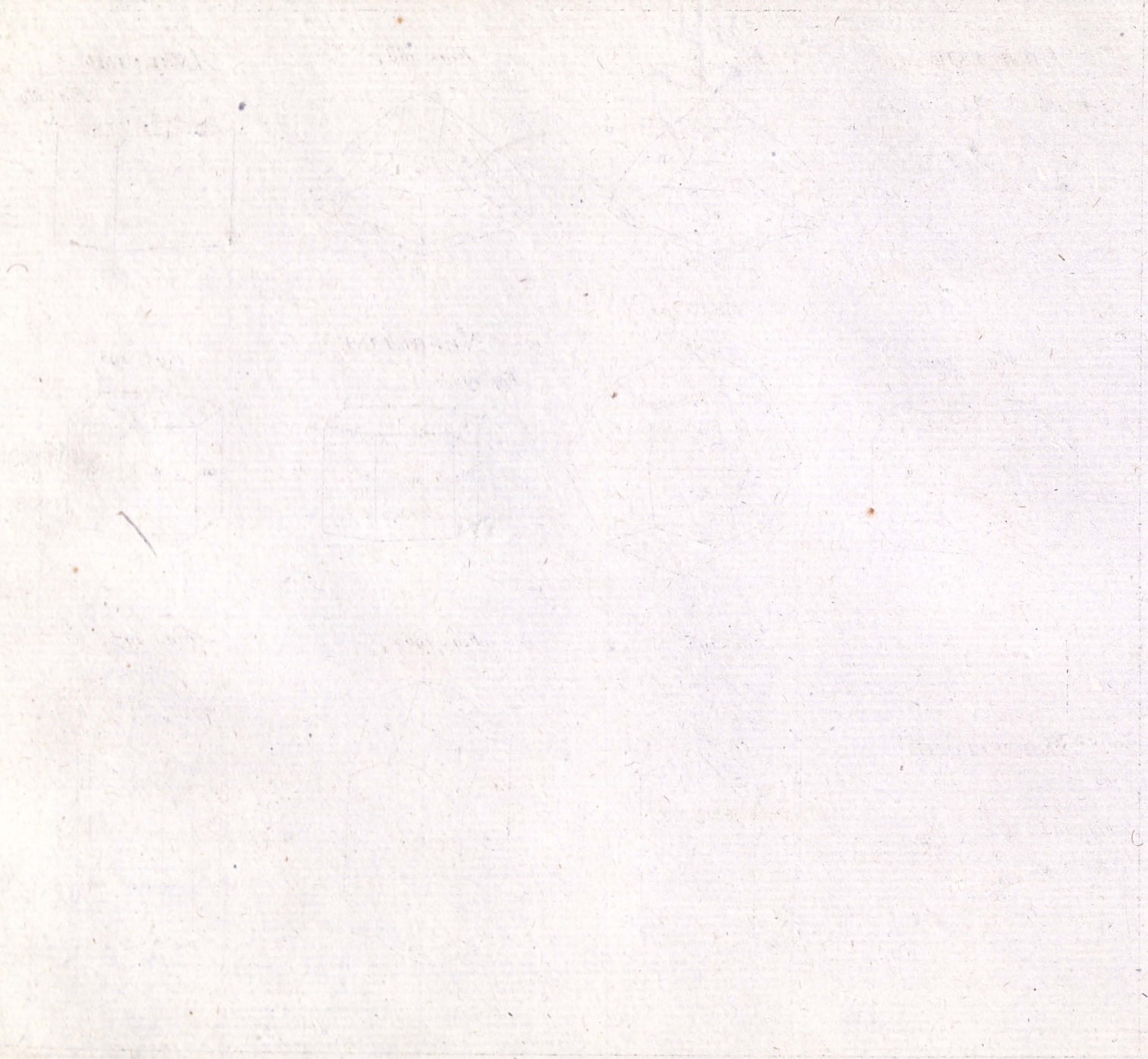

Fig. 185.



Faint header text at the top of the page, possibly a title or reference number.



CHABASIE

Fig. 186.

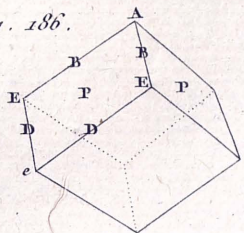

Fig. 187.

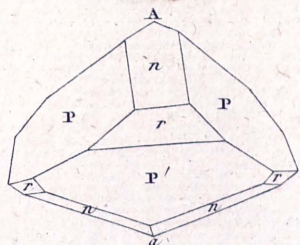
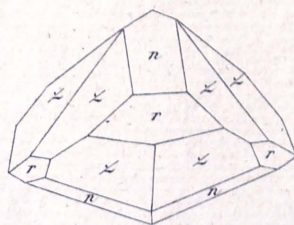

Fig. 188.



ANALCIME

Fig. 189.

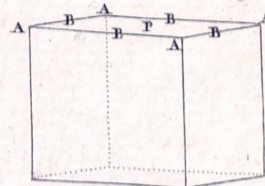

Fig. 190.

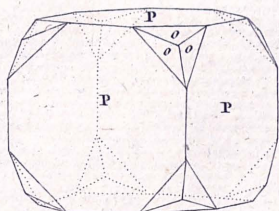
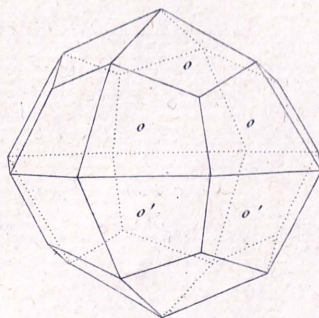

Fig. 191.



NEPHELINE

Fig. 192.

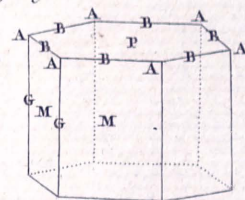

Fig. 193.

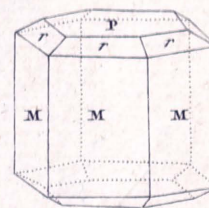

Fig. 195.

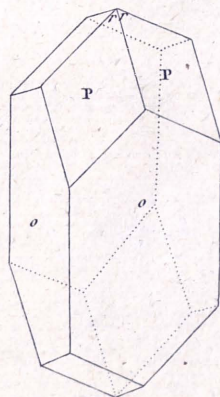

Fig. 196.

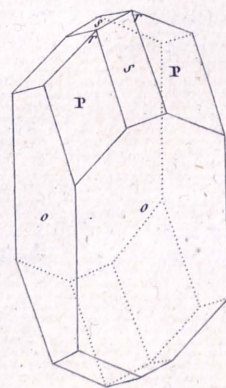
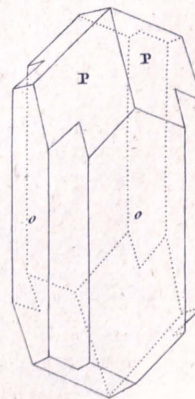
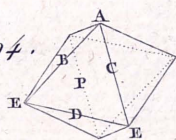

Fig. 197.



HARMOTOME

Fig. 194.





PERIDOT

Fig. 198.

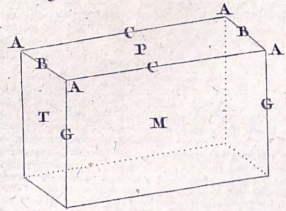

Fig. 199.

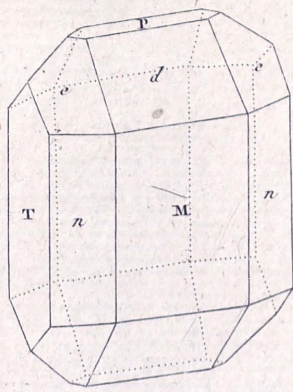

Fig. 200.

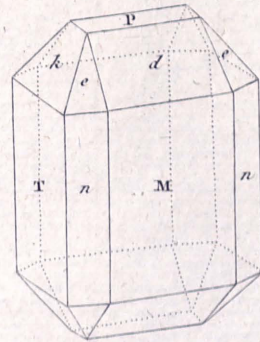

Fig. 201.

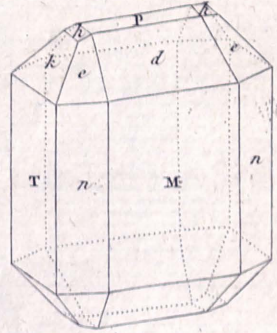

Fig. 202.

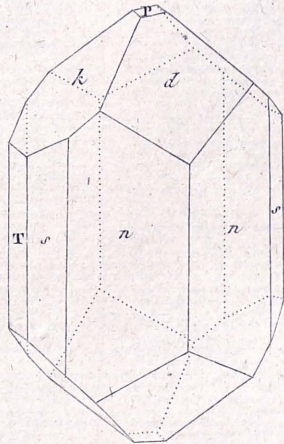

Fig. 203.

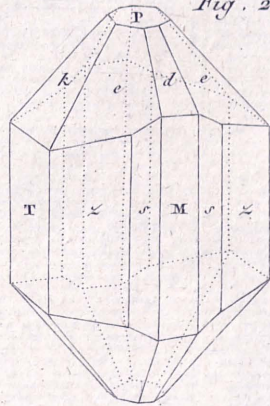
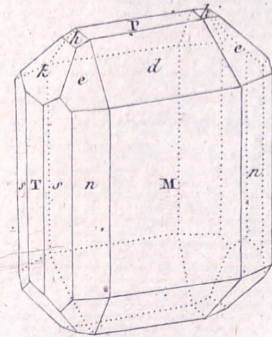

Fig. 204.



MICA

Fig. 205.

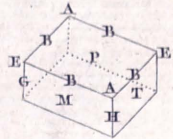

Fig. 206.

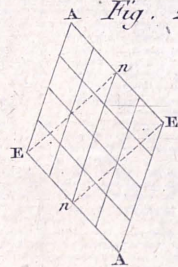

Fig. 207.

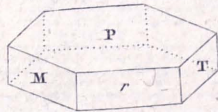

Fig. 208.

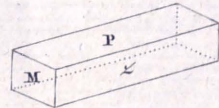
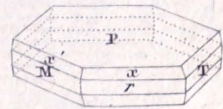
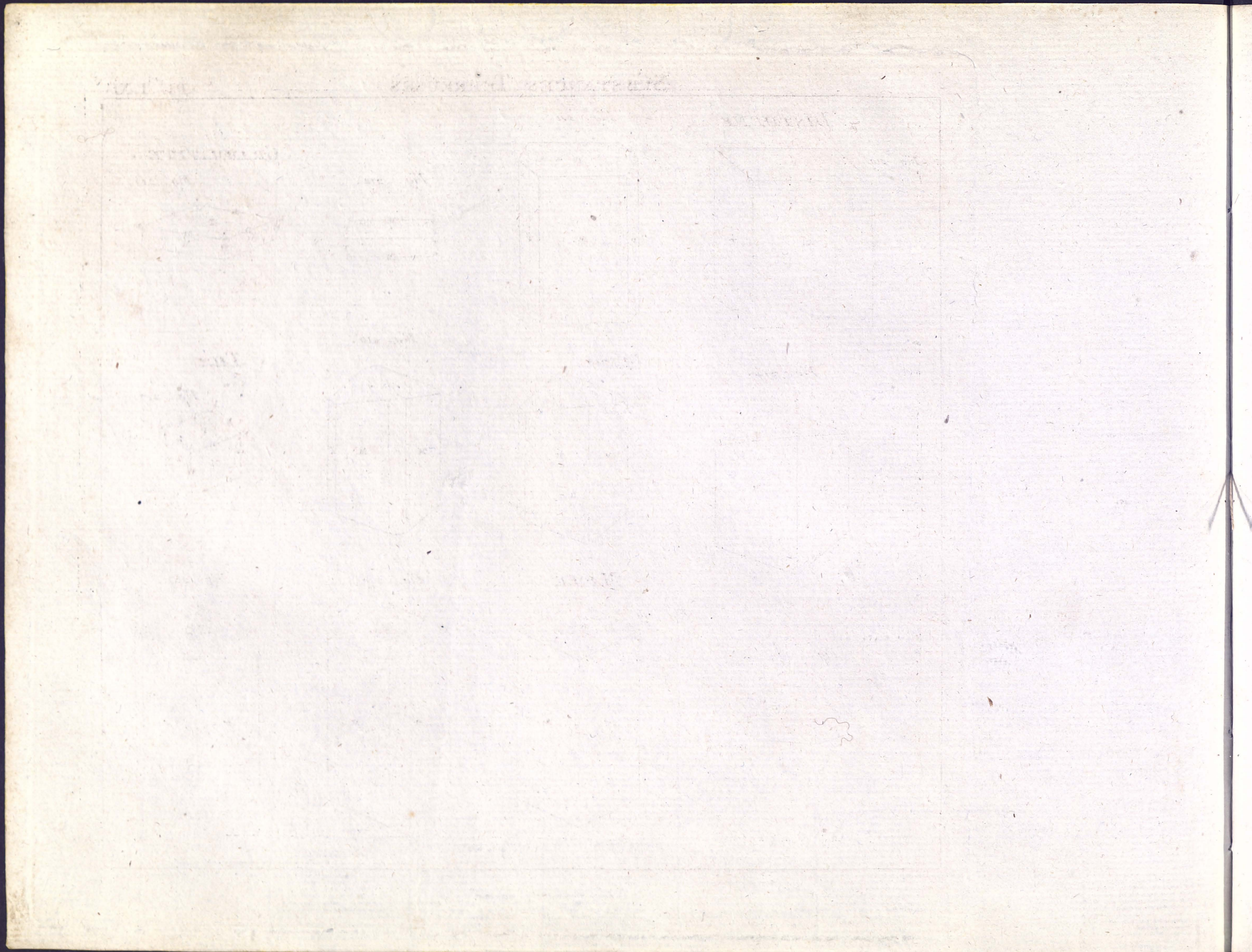

Fig. 209.





DISTHENE

Fig. 210.

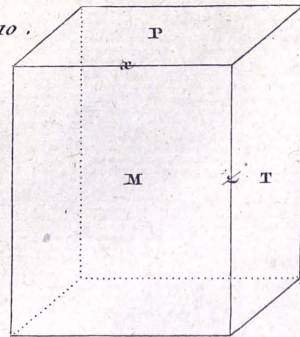

Fig. 211.

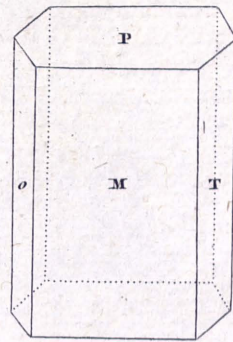
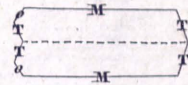

Fig. 212.



GRAMMATITE

Fig. 213.

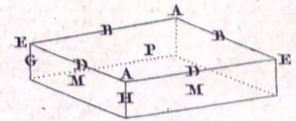

Fig. 214.

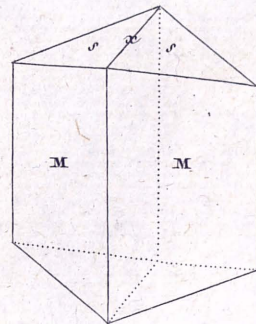

Fig. 215.

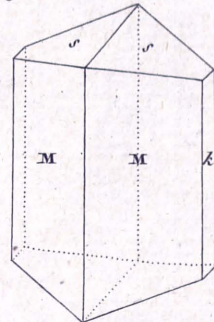
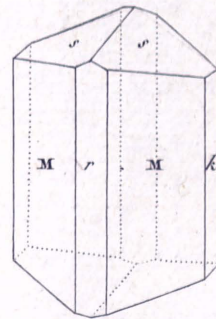
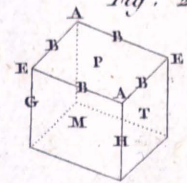

Fig. 216.



TALC

Fig. 217.



MACLE

Fig. 219.

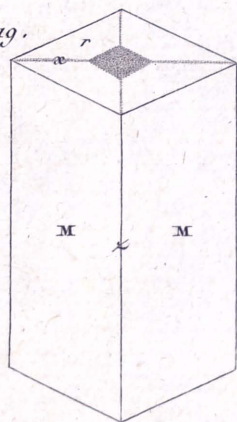

Fig. 220.

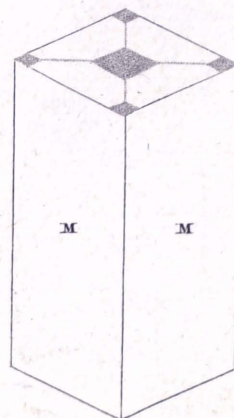

Fig. 221.

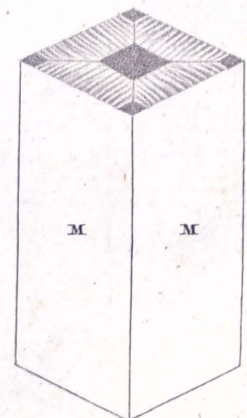

Fig. 218.

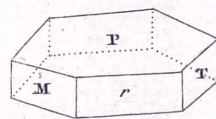

Fig. 1



Fig. 2



Fig. 3



Fig. 4

Fig. 5



Fig. 6

Fig. 7



Fig. 8



Fig. 9



Fig. 10



Fig. 11

Fig. 12



SOUFRE

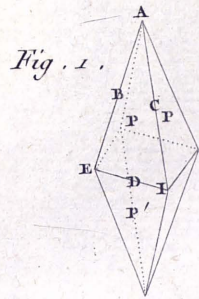

Fig. 2.

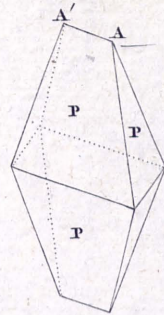

Fig. 3.

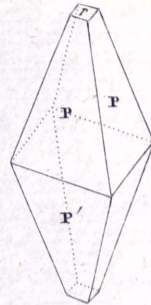

Fig. 4.

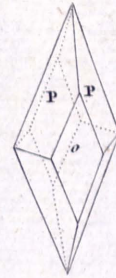

Fig. 5.

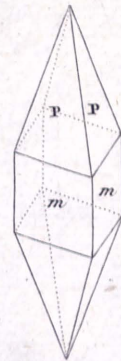

Fig. 6.

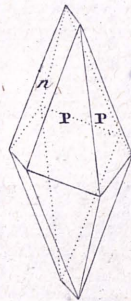

Fig. 7.

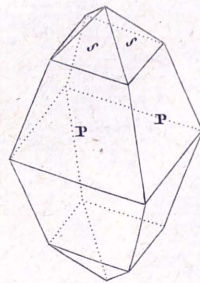

Fig. 8.

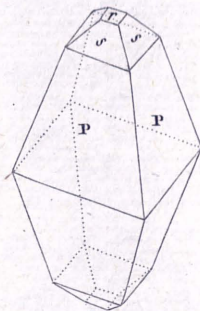
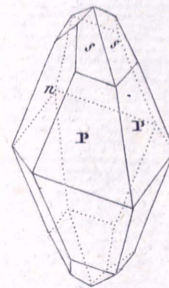

Fig. 9.



DIAMANT

Fig. 10.

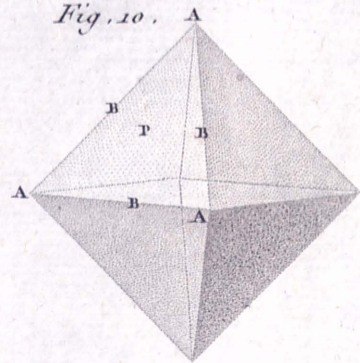
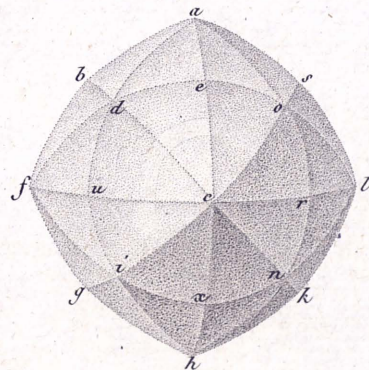

Fig. 11.



MELLITE

Fig. 12.

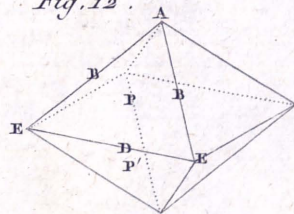

Fig. 13.

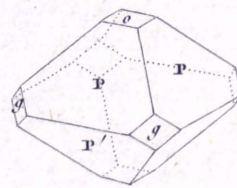
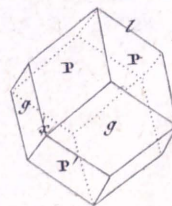
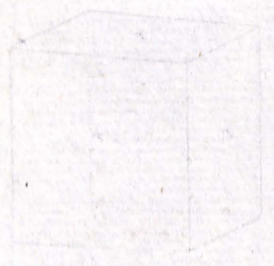

Fig. 14.



THE NEW METHOD OF DRAWING
THE NEW METHOD OF DRAWING



OR NATIF, ARGENT NATIF, ARGENT SULFURE
CUIVRE NATIF ET COBALT ARSENICAL

Fig. 1.

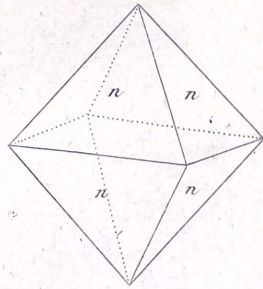

Fig. 5.

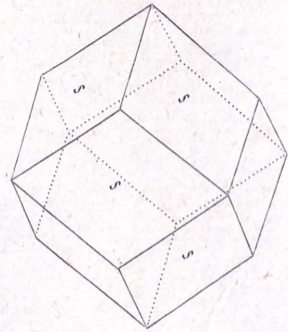

Fig. 3.

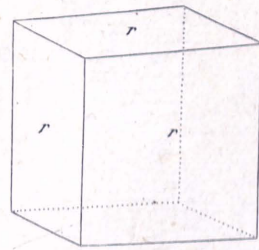

Fig. 4.

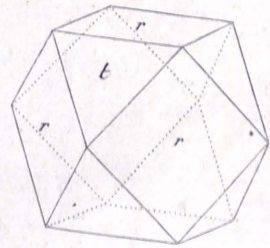

Fig. 2.

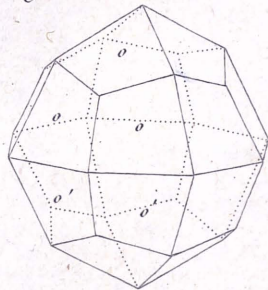

Fig. 6.

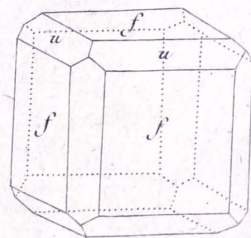
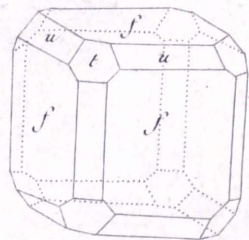

Fig. 7.





ARGENT ANTIMONIE SULFURE

Fig. 8.

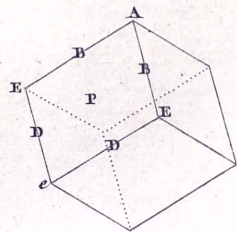

Fig. 9.

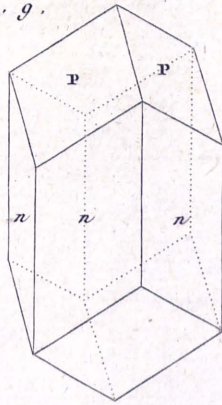

Fig. 10.

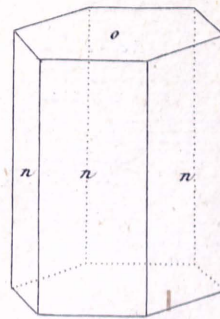

Fig. 11.

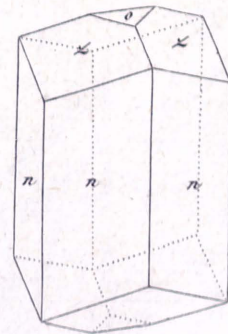

Fig. 12.

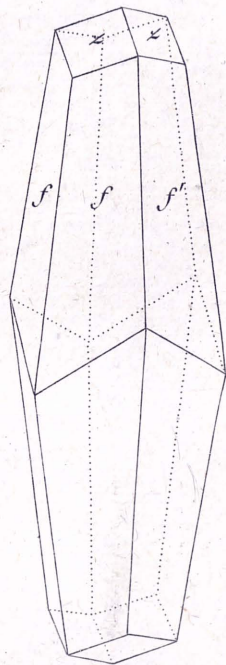

Fig. 13.

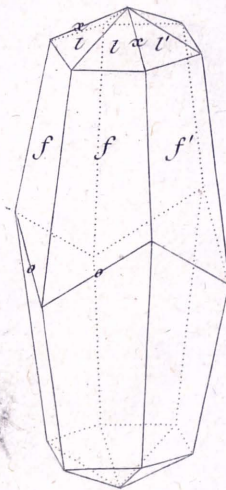

Fig. 14.

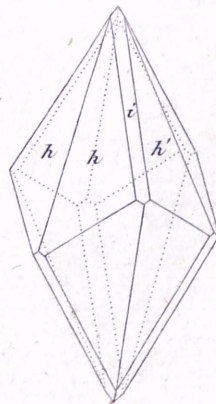

Fig. 15.

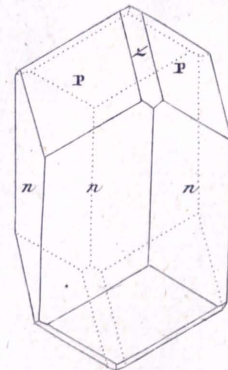
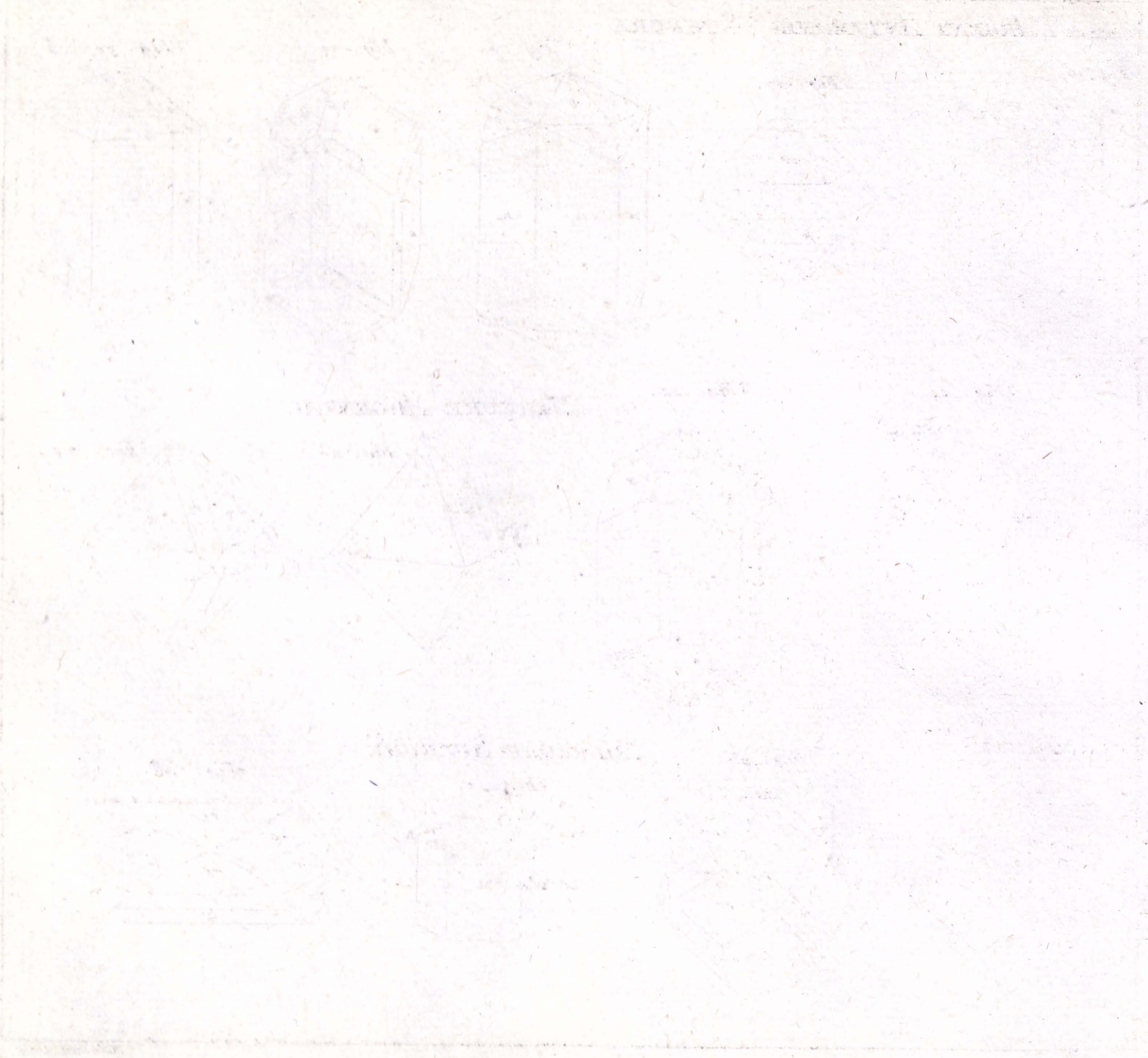

PLATE I. THE ARCHITECTURE OF THE TEMPLE OF SATURN AT CAPUA.



Suite de L'ARGENT ANTIMONIE' SULFURE'

Fig. 16.

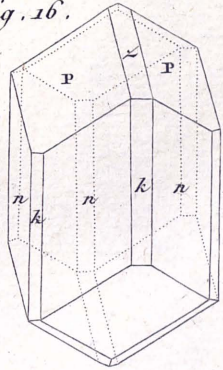

Fig. 17.

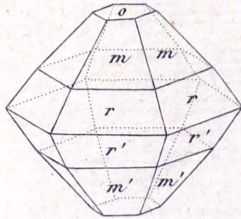

Fig. 18.

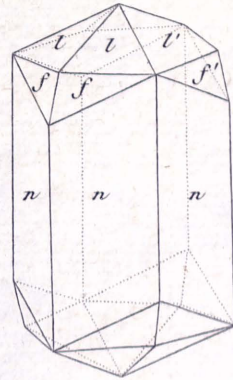

Fig. 19.

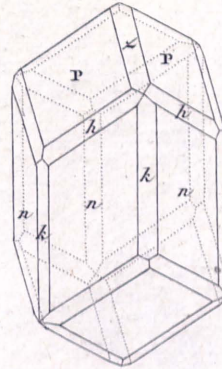

Fig. 20.

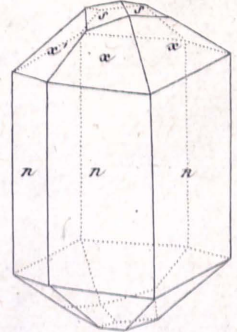

Fig. 21.

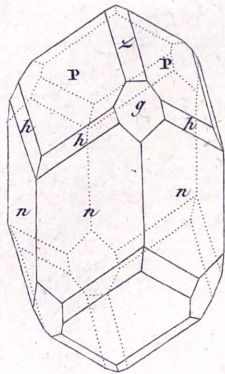
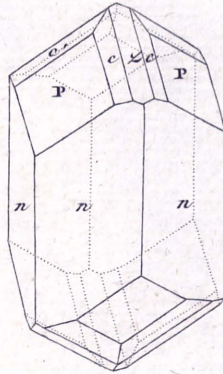

Fig. 22.



MERCURE ARGENTAL

Fig. 23.

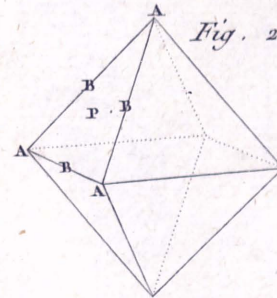

Fig. 24.

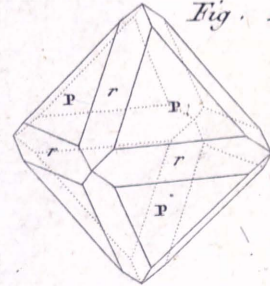

Fig. 25.

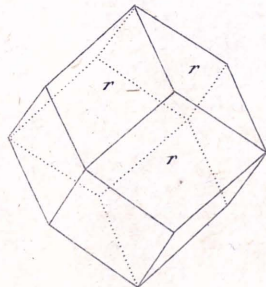
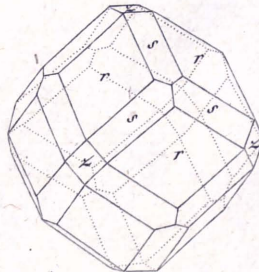

Fig. 26.



MERCURE SULFURE'

Fig. 27.

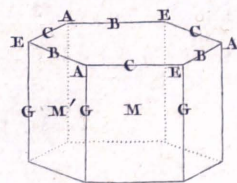
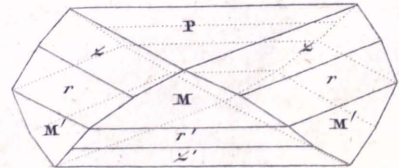

Fig. 28.





MERCURE MURIATÉ.

PLOMB SULFURÉ

Fig. 29.

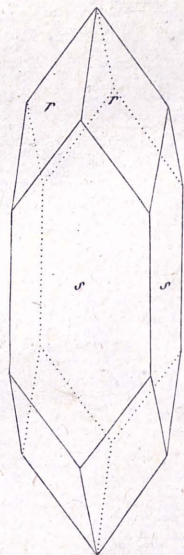

Fig. 30.

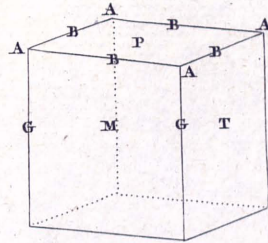

Fig. 31.

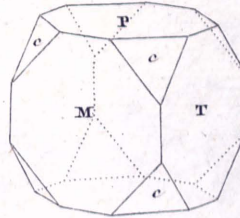

Fig. 32.

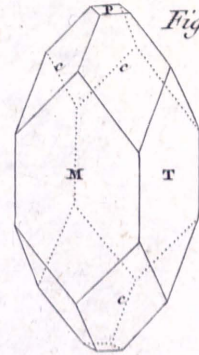

Fig. 35.

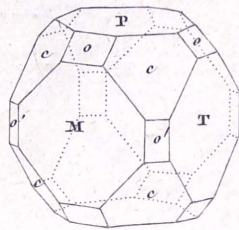

Fig. 33.

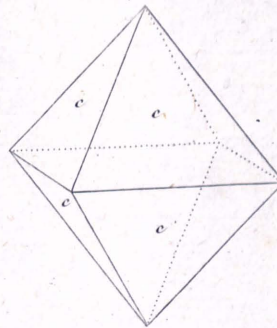

Fig. 34.

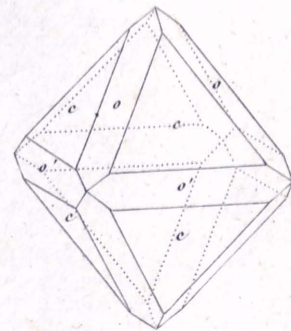

Fig. 37.

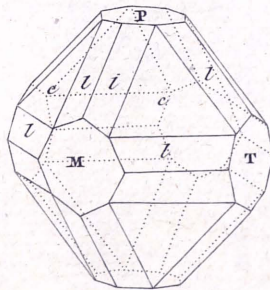

Fig. 38.

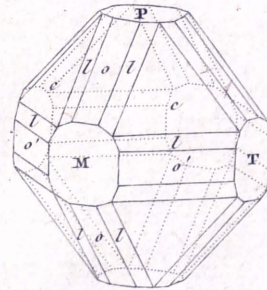
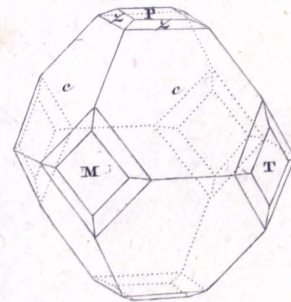
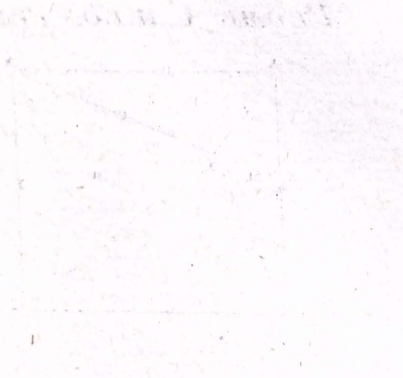

Fig. 36.





PLOMB CHROMATE

Fig. 39.

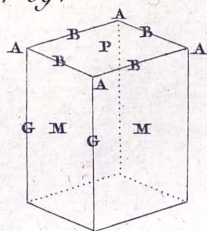

Fig. 40.

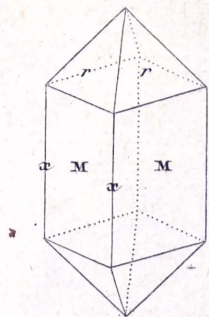

Fig. 41.

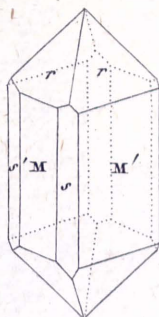

Fig. 42.

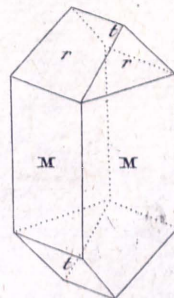
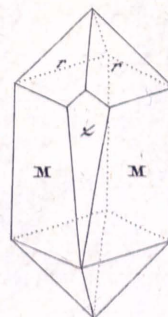

Fig. 43.



PLOMB CARBONATE

Fig. 44.

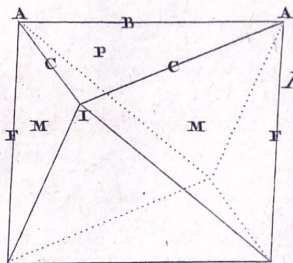

Fig. 45.

Fig. 46.

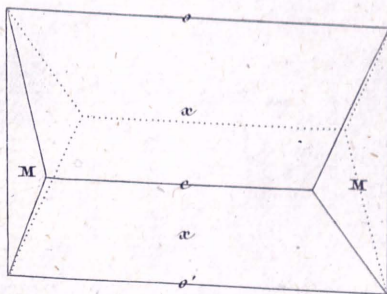

Fig. 47.

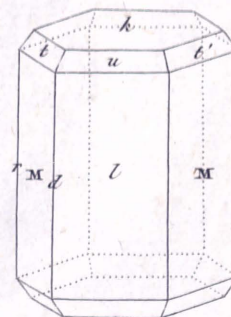

Fig. 49.

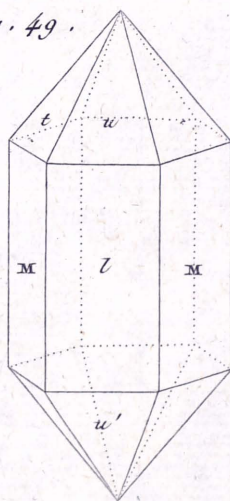

Fig. 48.

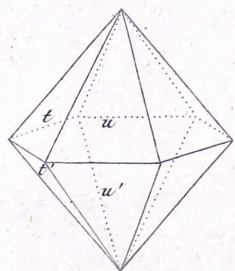

Fig. 50.

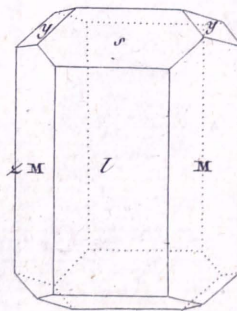
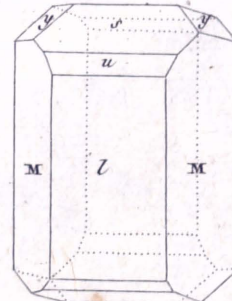
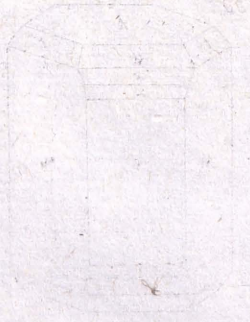
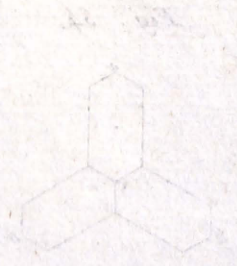
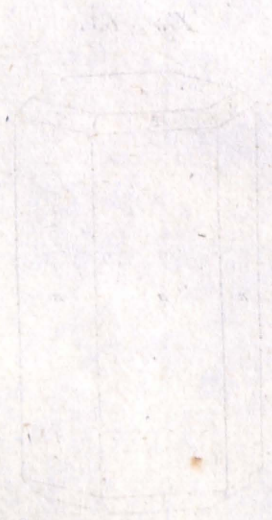

Fig. 51.





PROPOSITION I



Suite du **PLOMB CARBONATE**

Fig. 52.

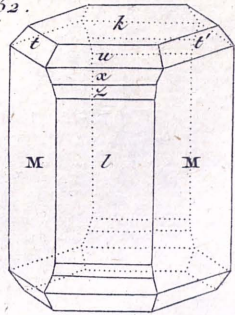

Fig. 53

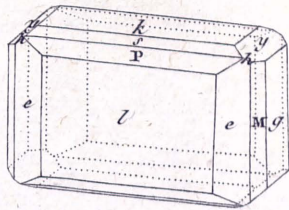

Fig. 54

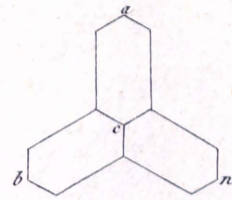
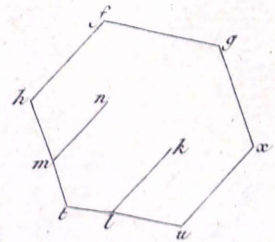

Fig. 55.



PLOMB PHOSPHATE

Fig. 56.

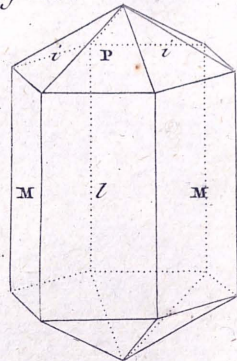

Fig. 57.

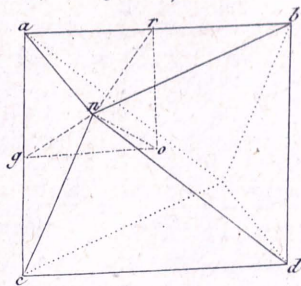

Fig. 58.

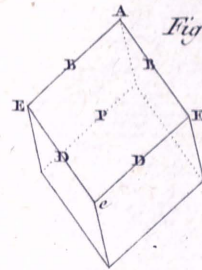

Fig. 59.

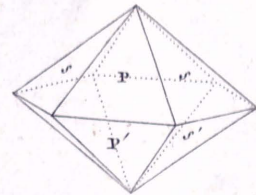

Fig. 60.

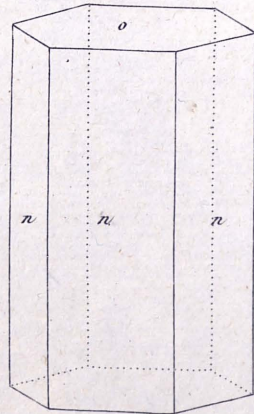

Fig. 61.

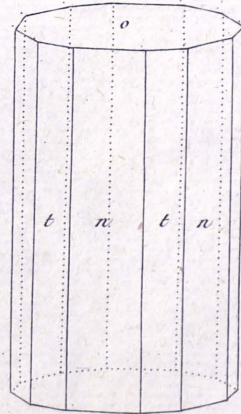

Fig. 62.

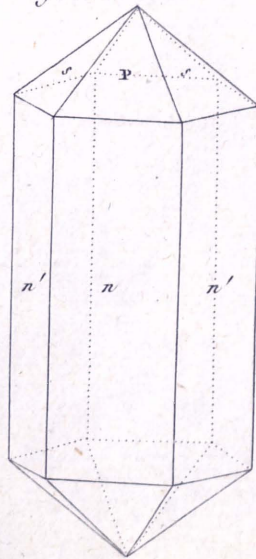

Fig. 63.

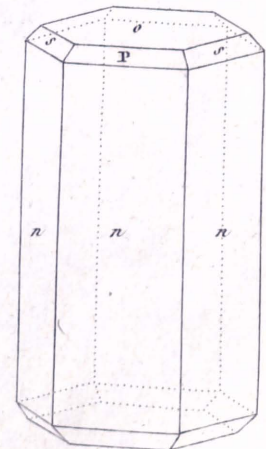
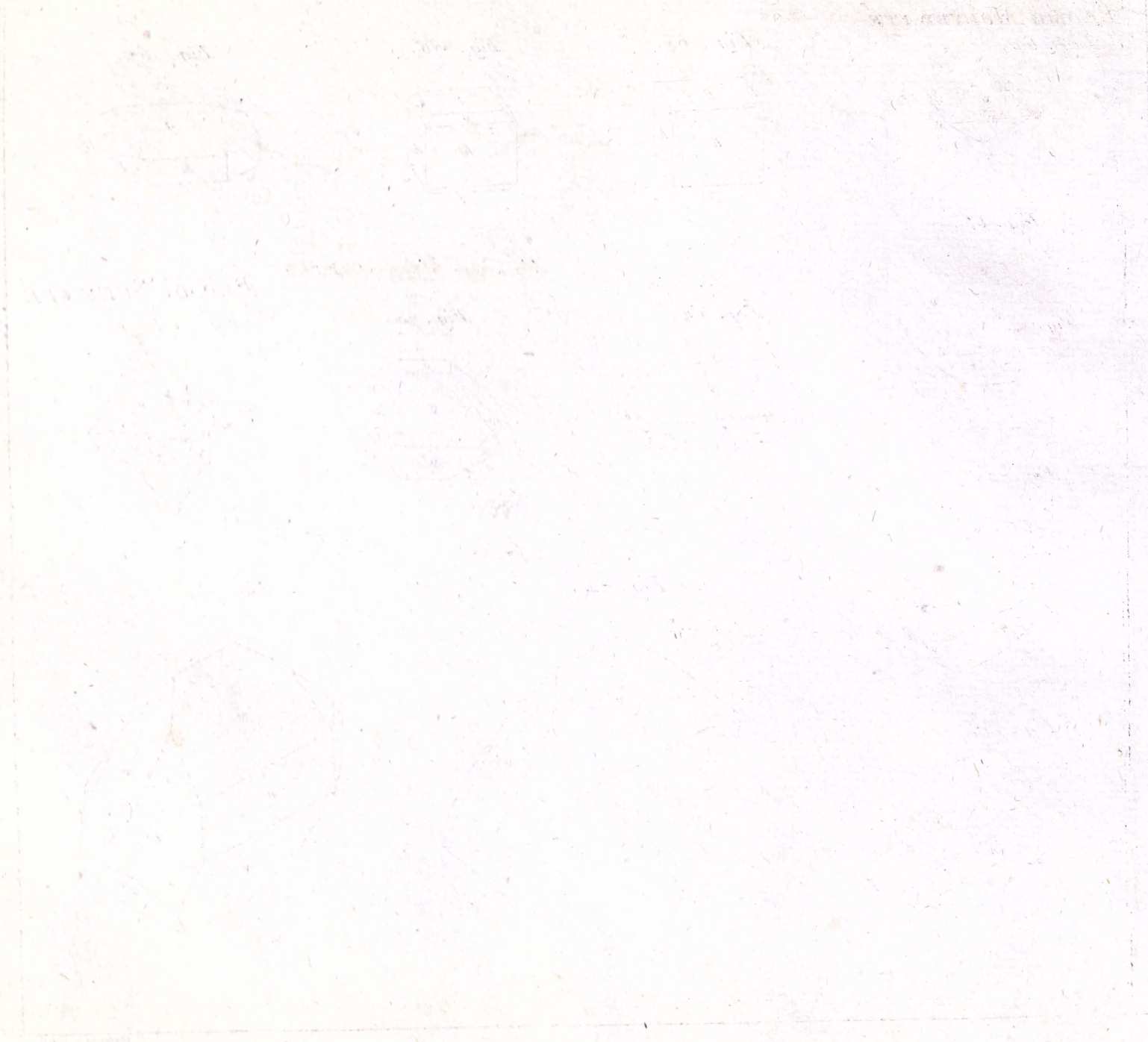

PLATE I. THE TEMPLE OF SATURN AT CAPUA.



Scale: 1/1000. The drawing is a plan view of the temple, showing the hexagonal base and the surrounding walls and porticoes.

PLOMB MOLYBDATE

Fig. 64.

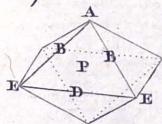

Fig. 65.

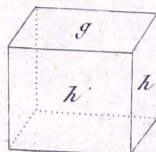

Fig. 66.

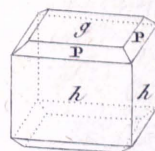

Fig. 67.

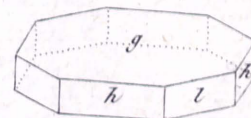

Fig. 68.

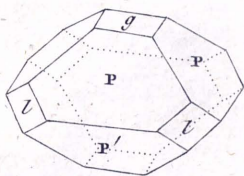

Fig. 69.

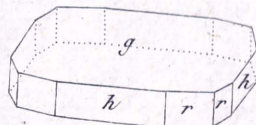
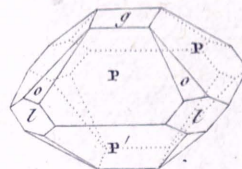

Fig. 70.



PLOMB SULFATE

Fig. 71.

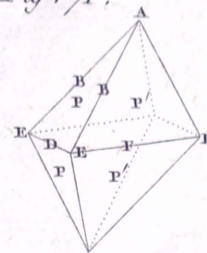

Fig. 72.

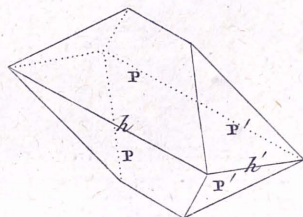

Fig. 74.

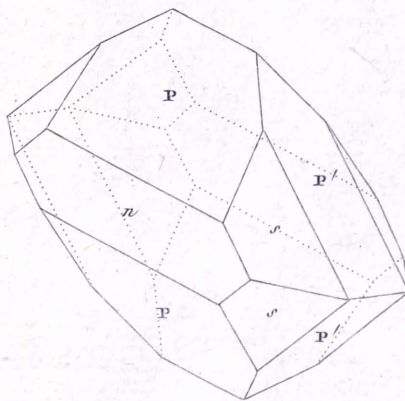

Fig. 75.

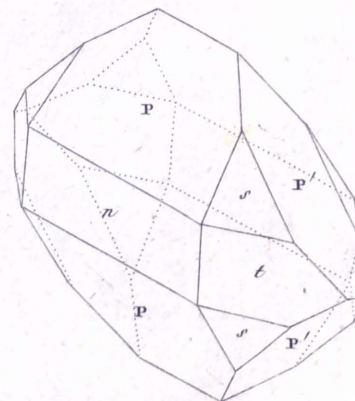

Fig. 73.

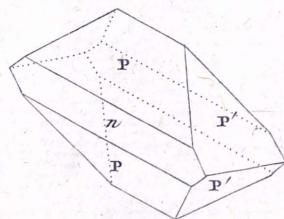

PLATE I

PROJECTIONS OF A CUBE

FIG. 1

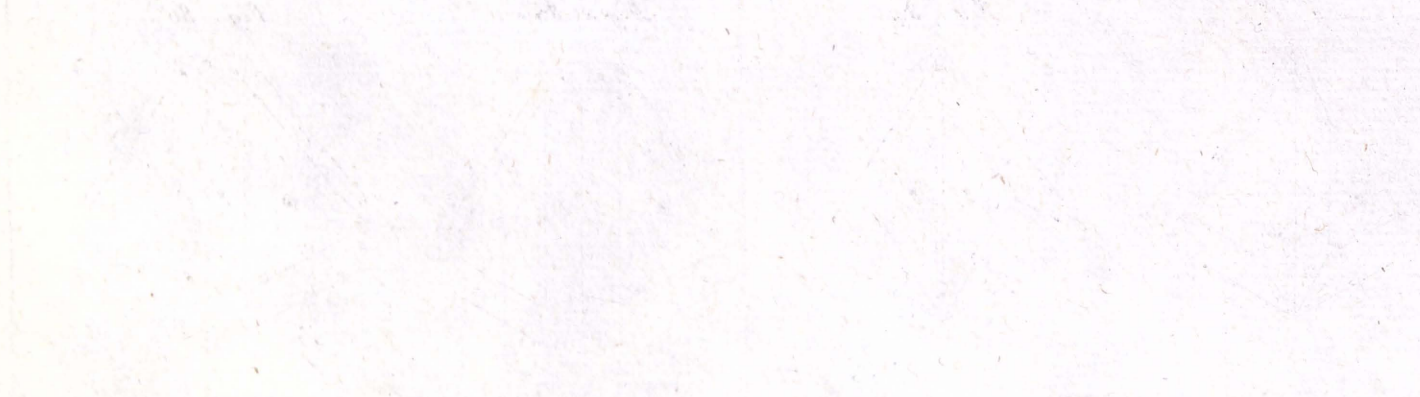
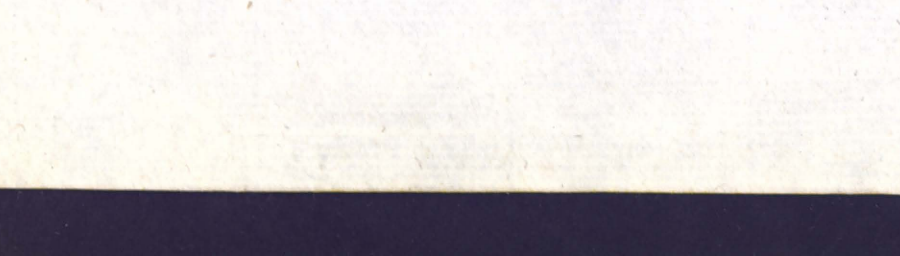

PLATE II

PROJECTIONS OF A CUBE

FIG. 2



Suite du **PLOMB SULFATE**

CUIVRE GRIS ET CUIVRE PYRITEUX

Fig. 76.

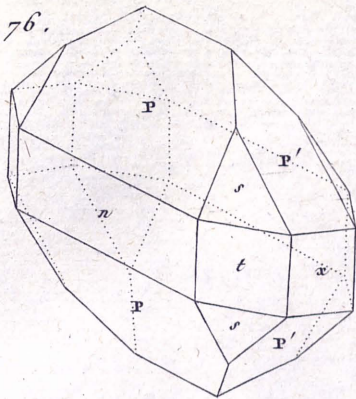

Fig. 77.

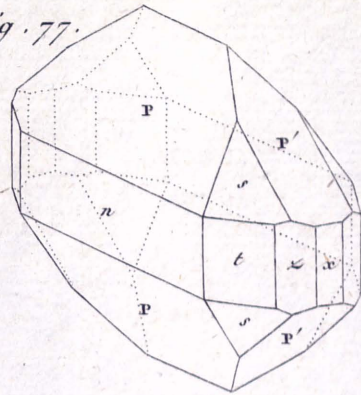

Fig. 78.

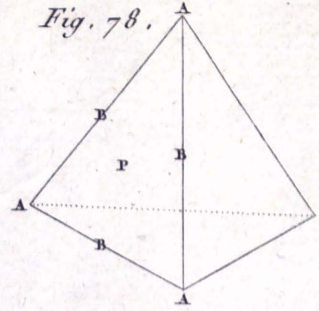

Fig. 79.

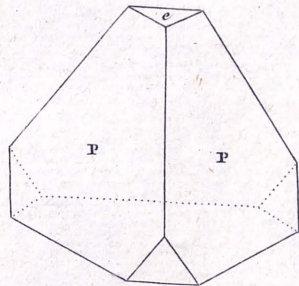

Fig. 80.

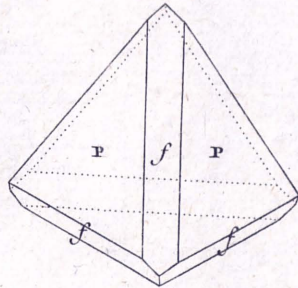

Fig. 81.

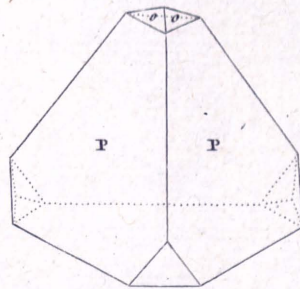

Fig. 82.

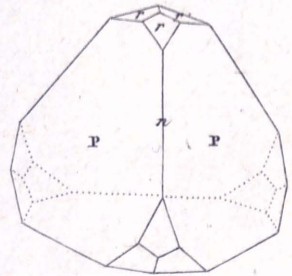

Fig. 83.

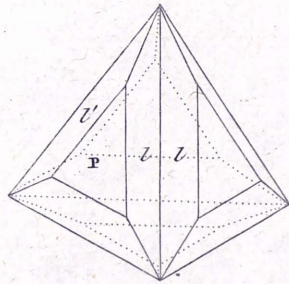

Fig. 84.

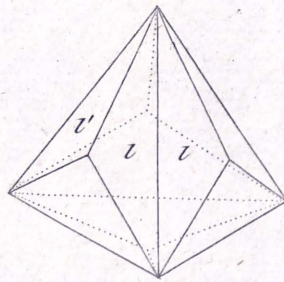

Fig. 85.

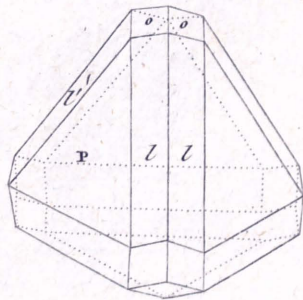

Fig. 86.

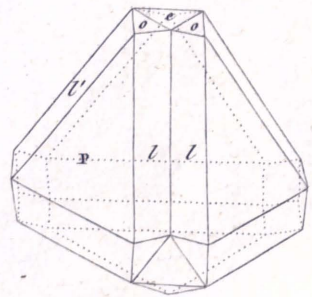
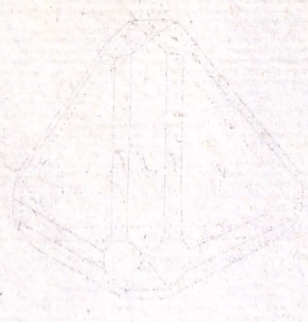
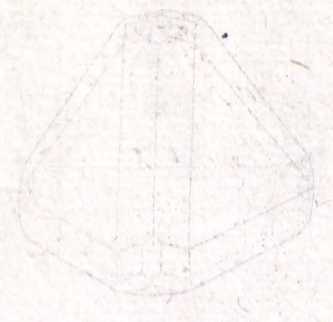

Fig. 1

Fig. 2

Fig. 3

Fig. 4



Suite du CUIVRE GRIS

Fig. 87.

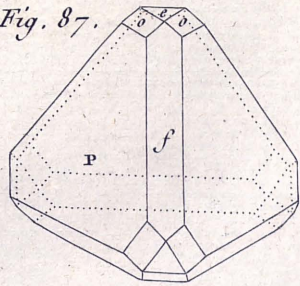

Fig. 88.

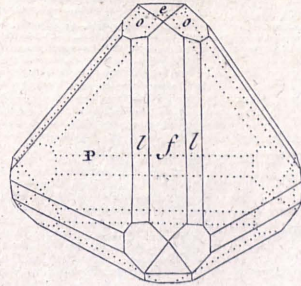

Fig. 89.

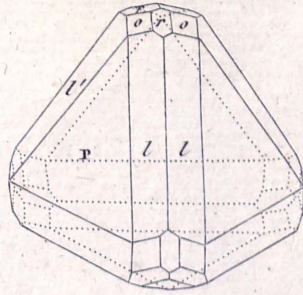
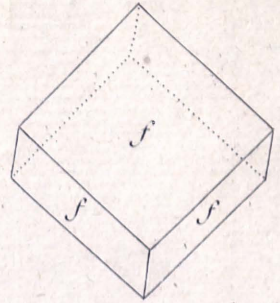

Fig. 90.



CUIVRE OXYDÉ ROUGE

Fig. 91.

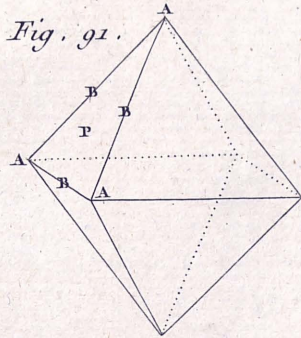

Fig. 92.

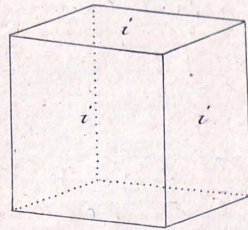

Fig. 93.

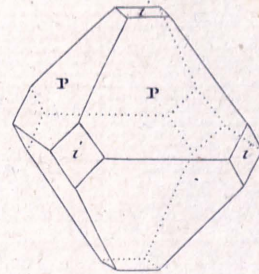
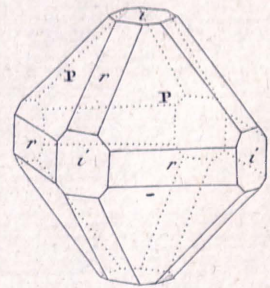

Fig. 94.



CUIVRE CARBONATÉ BLEU

Fig. 95.

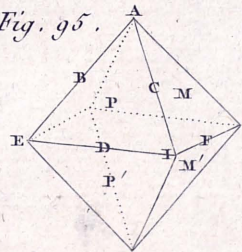

Fig. 96.

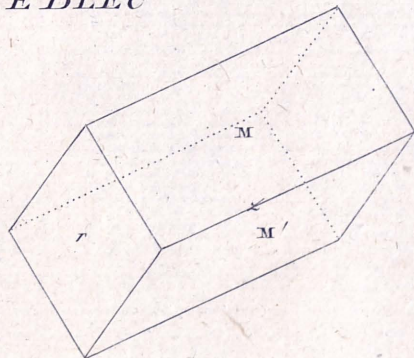

Fig. 97.



Tabla de las Cajas de los Metales



Suite du CUIVRE CARBONATE BLEU

Fig. 98.

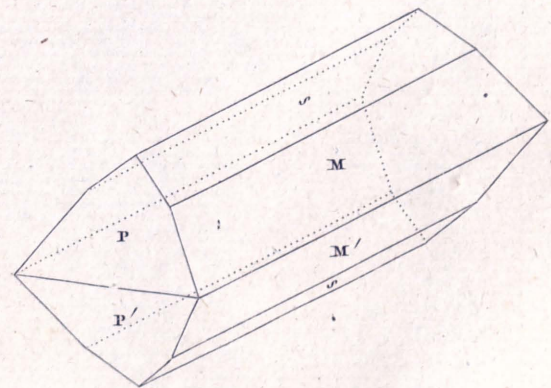
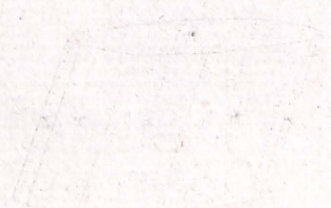
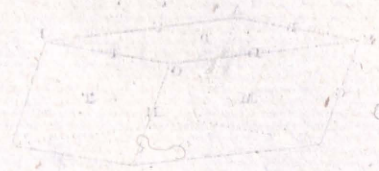
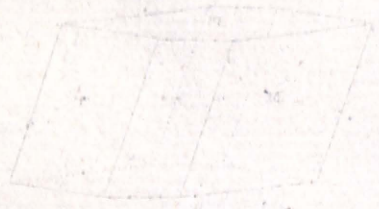
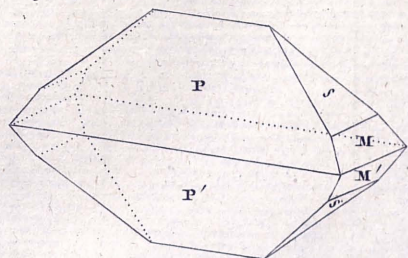

Fig. 99.

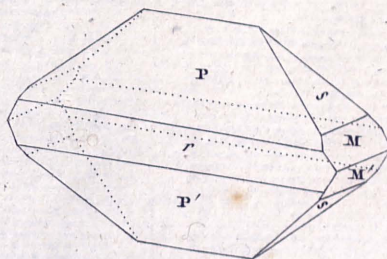

Fig. 100.

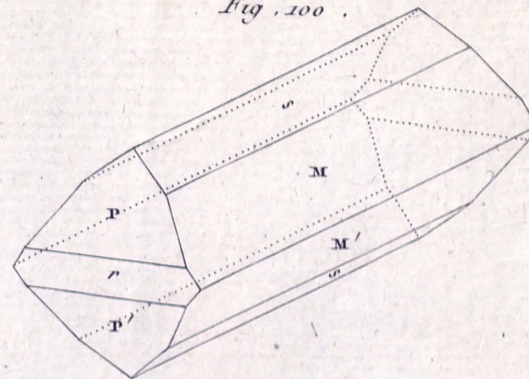
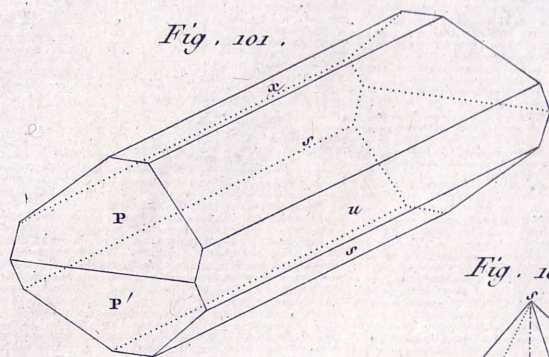

Fig. 101.



CUIVRE SULFATE

Fig. 103.

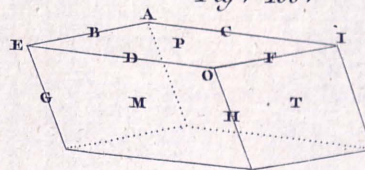

Fig. 104.

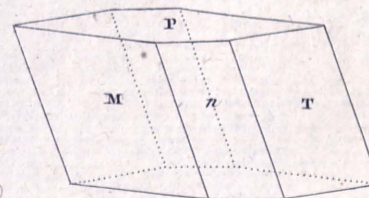

Fig. 102.

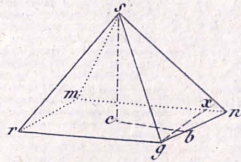

Fig. 105.

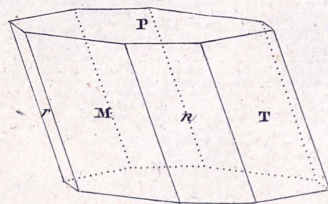

Fig. 106.

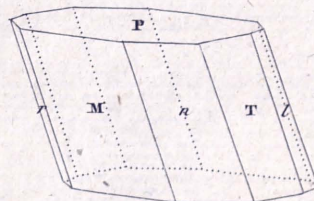
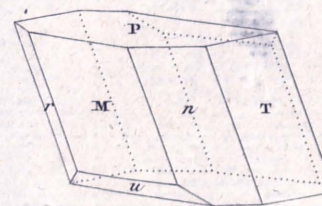

Fig. 107.



1774

1774

1774

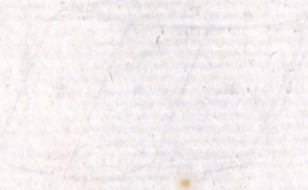
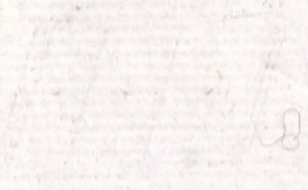

Suite du CUIVRE SULFATE

Fig. 108.

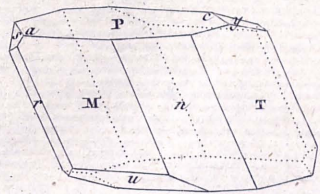

Fig. 109.

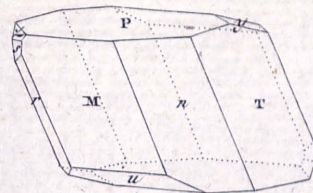

Fig. 110.

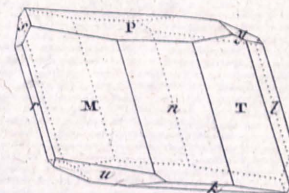

Fig. 111.

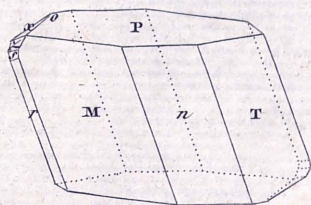

Fig. 112.

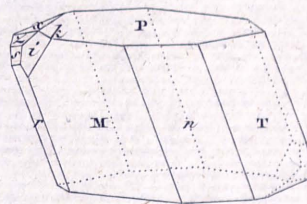

Fig. 113.

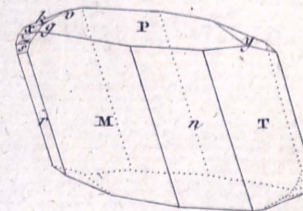
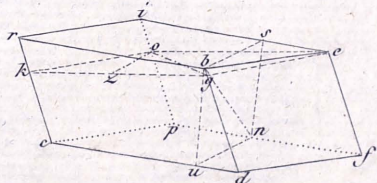

Fig. 114.



NICKEL

Fig. 115.

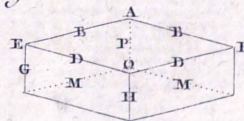

Fig. 116.

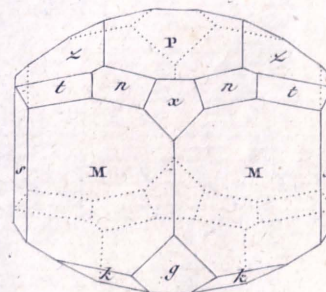

FIG. 1



L

FER OXYDULÉ

Fig. 117.

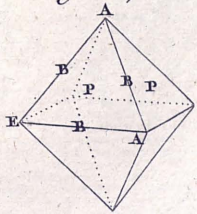

Fig. 118.

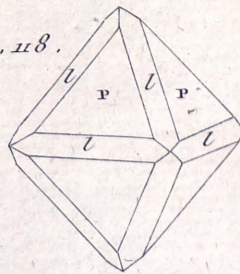

Fig. 119.

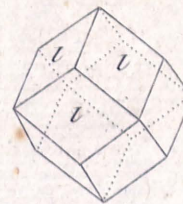
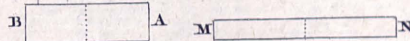

Fig. 120.



FER OLIGISTE

Fig. 122.

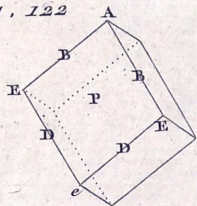

Fig. 121.

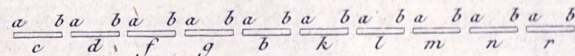

Fig. 123.

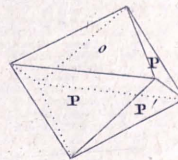

Fig. 124.

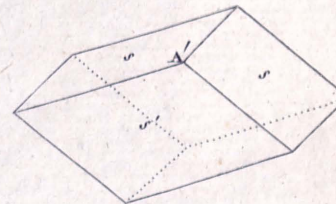

Fig. 126.

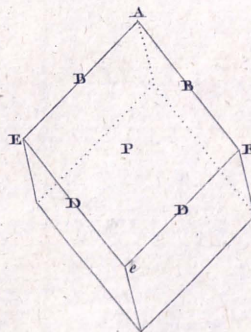

Fig. 127.

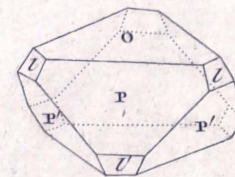

Fig. 125.

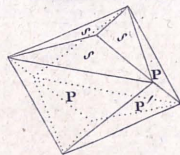
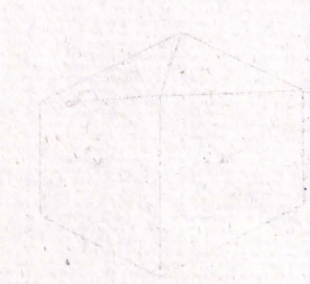
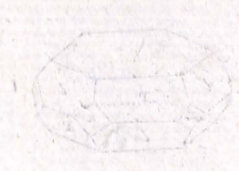
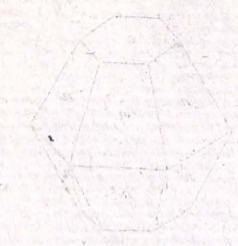
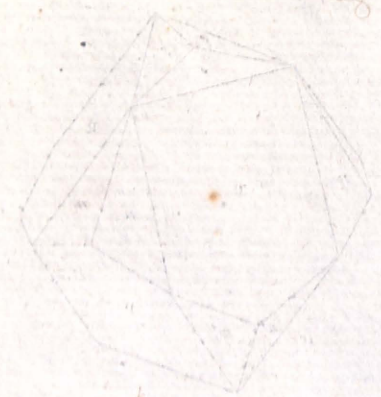
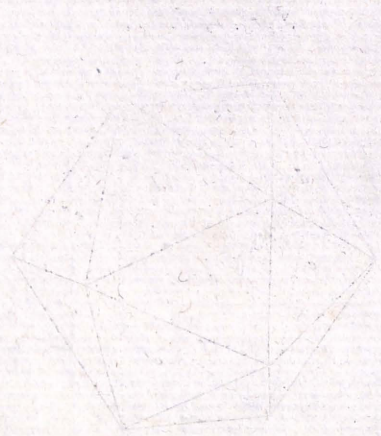
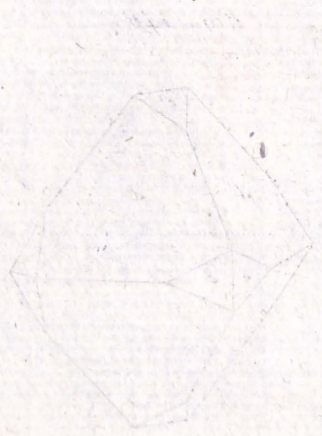
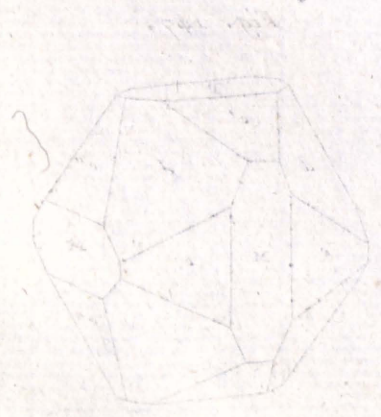
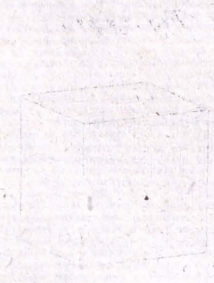
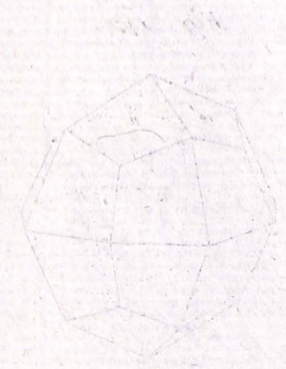
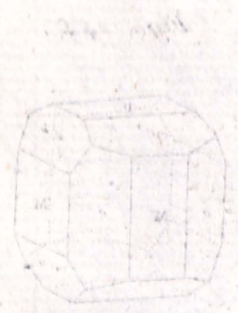
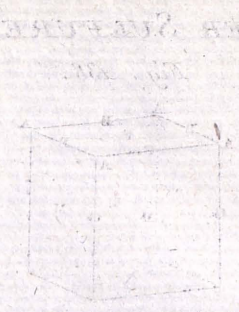
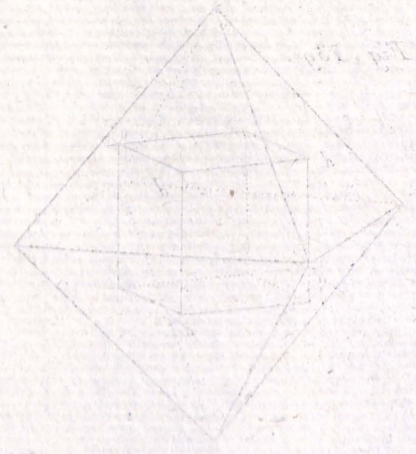

PLATE XXV

MINERALOGY





FER SULFURE

Fig. 138.

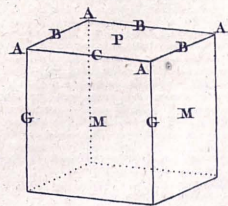

Fig. 139.

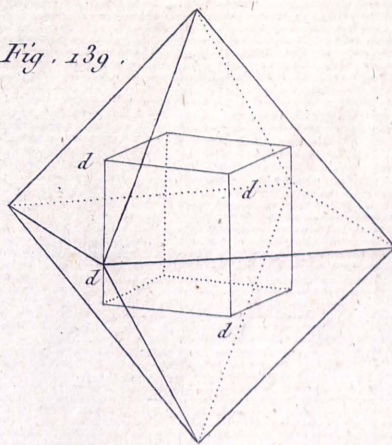

Fig. 140.

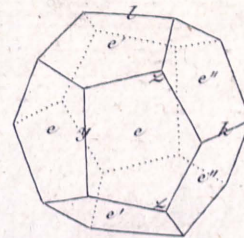

Fig. 141.

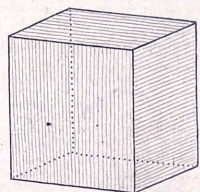

Fig. 142.

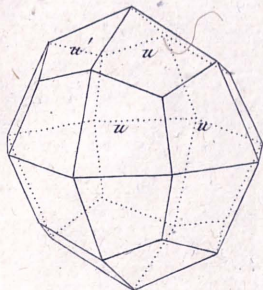

Fig. 143.

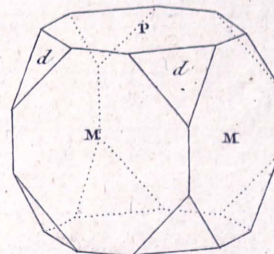

Fig. 144.

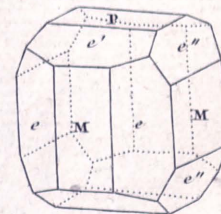

Fig. 145.

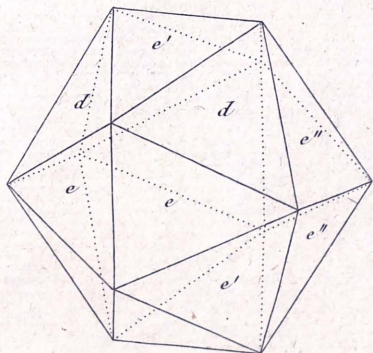

Fig. 146.

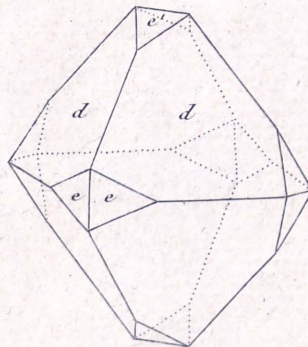
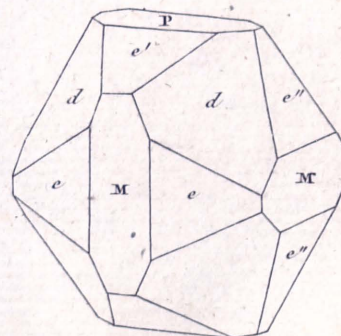
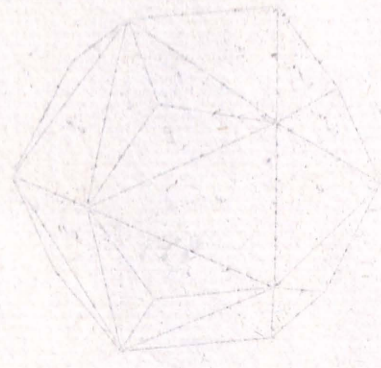
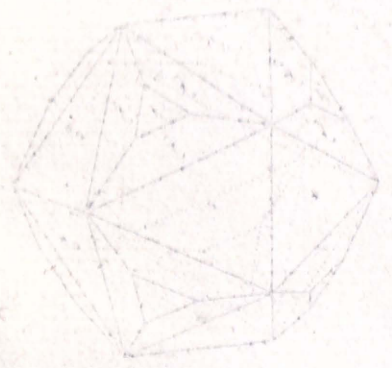
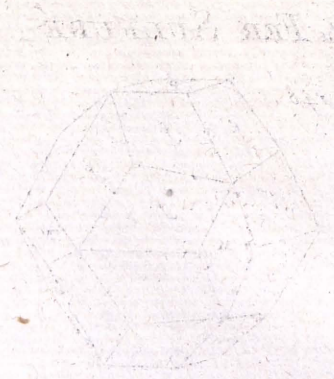
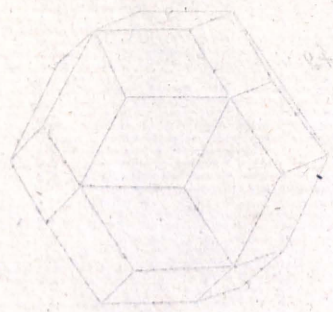
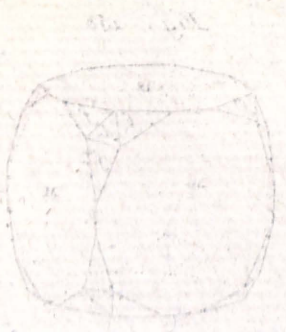

Fig. 147.





Suite du FER SULFURE

Fig. 148.

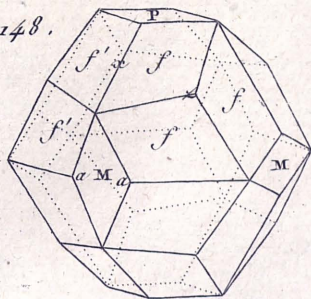

Fig. 149.

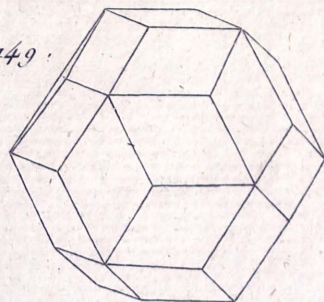

Fig. 150.

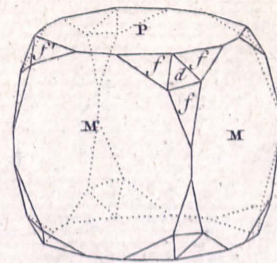

Fig. 151.

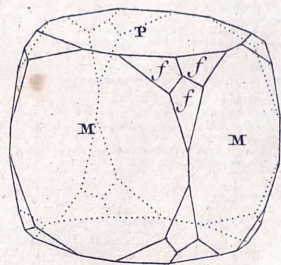

Fig. 152.

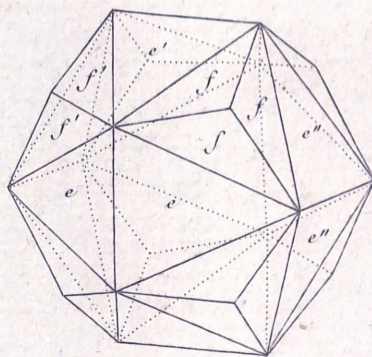

Fig. 153.

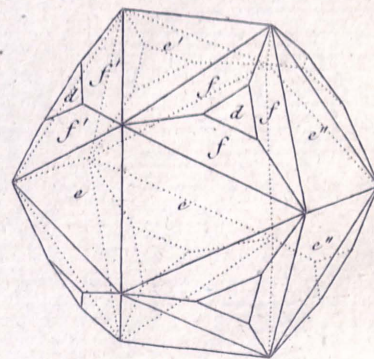

Fig. 154.

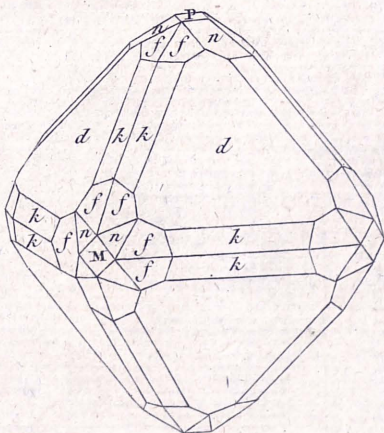

Fig. 155.

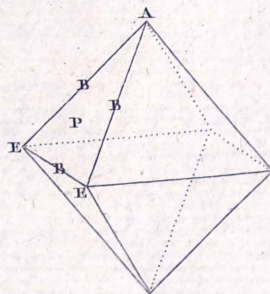

Fig. 156.

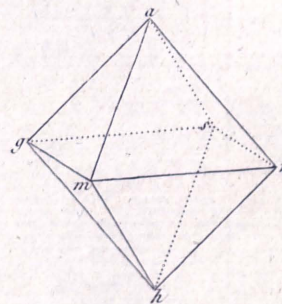
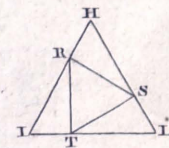

Fig. 157.



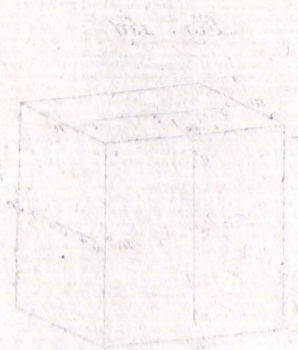
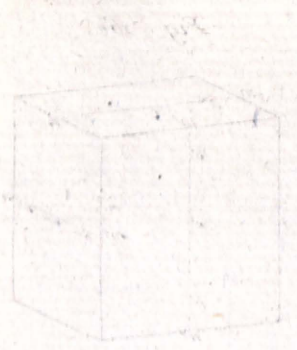

Fig. 109

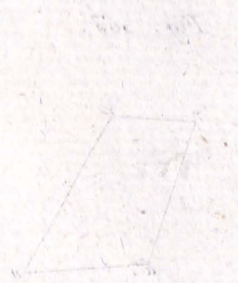

Fig. 114



Suite du FER SULFATE

Fig. 158.

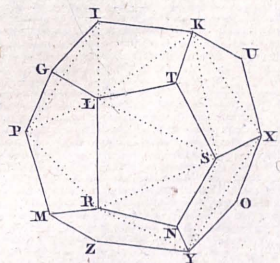

Fig. 159.

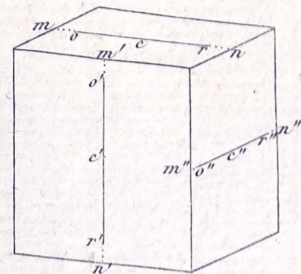

Fig. 160.

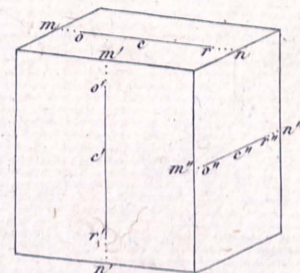

Fig. 161.

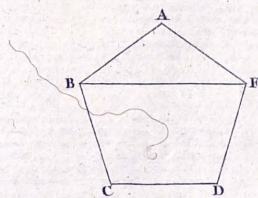

Fig. 162.

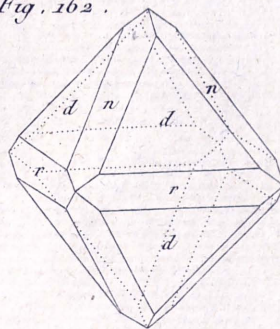

Fig. 163.

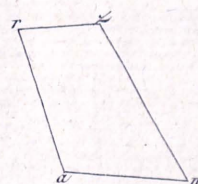
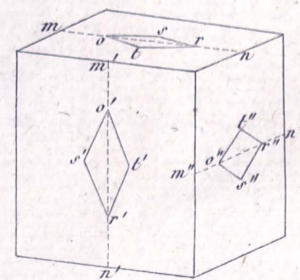

Fig. 164.



COBALT GRIS

Fig. 165.

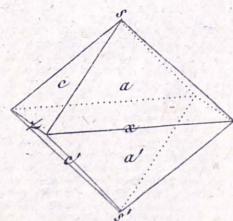

Fig. 166.

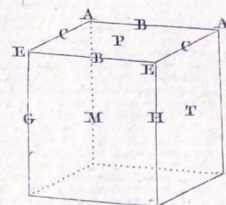
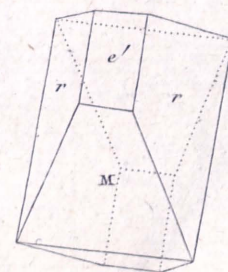
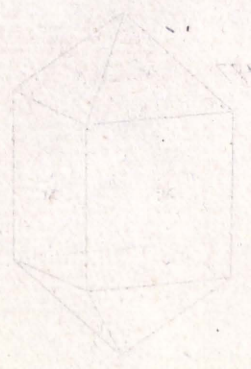
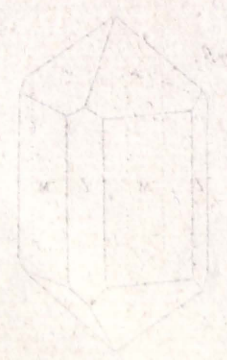
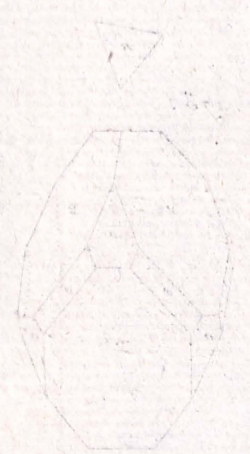
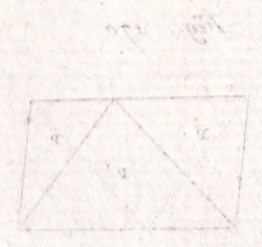

Fig. 167.



LES DIAMETS



FER SULFATE

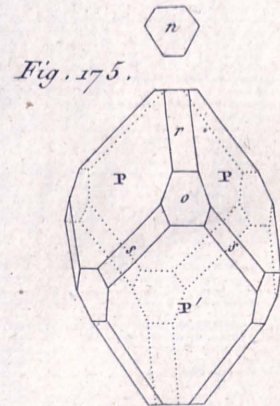
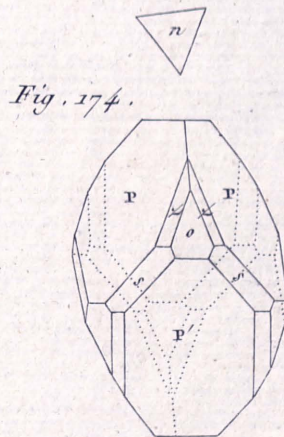
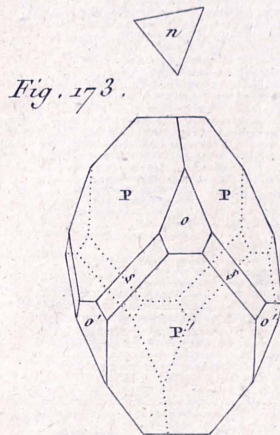
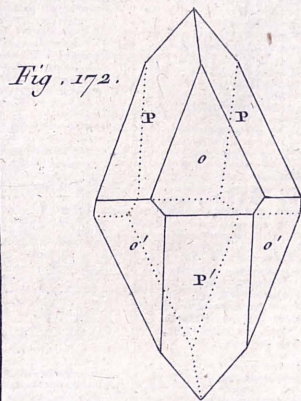
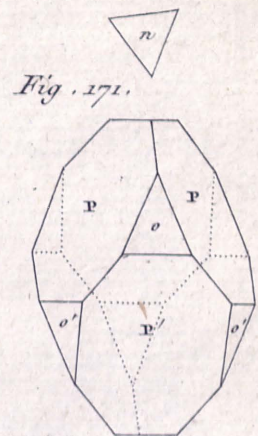
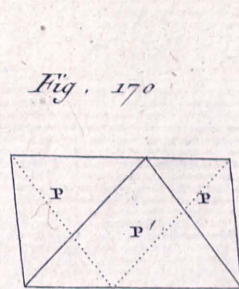
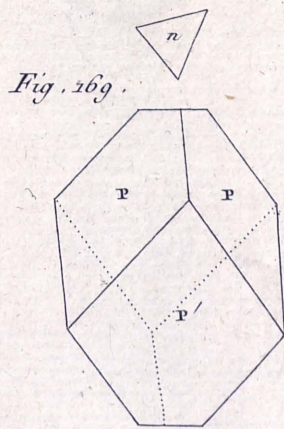
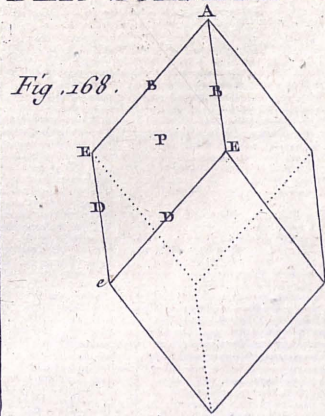

ETAIN OXYDE

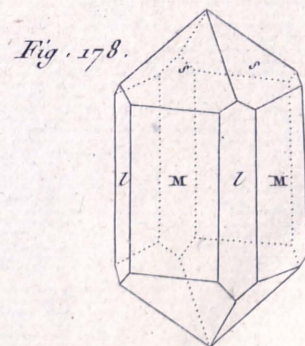
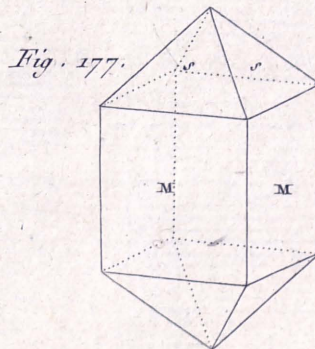
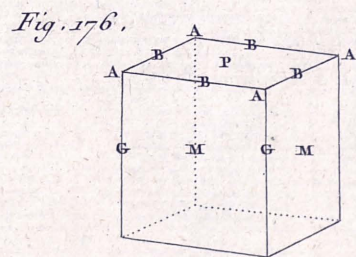

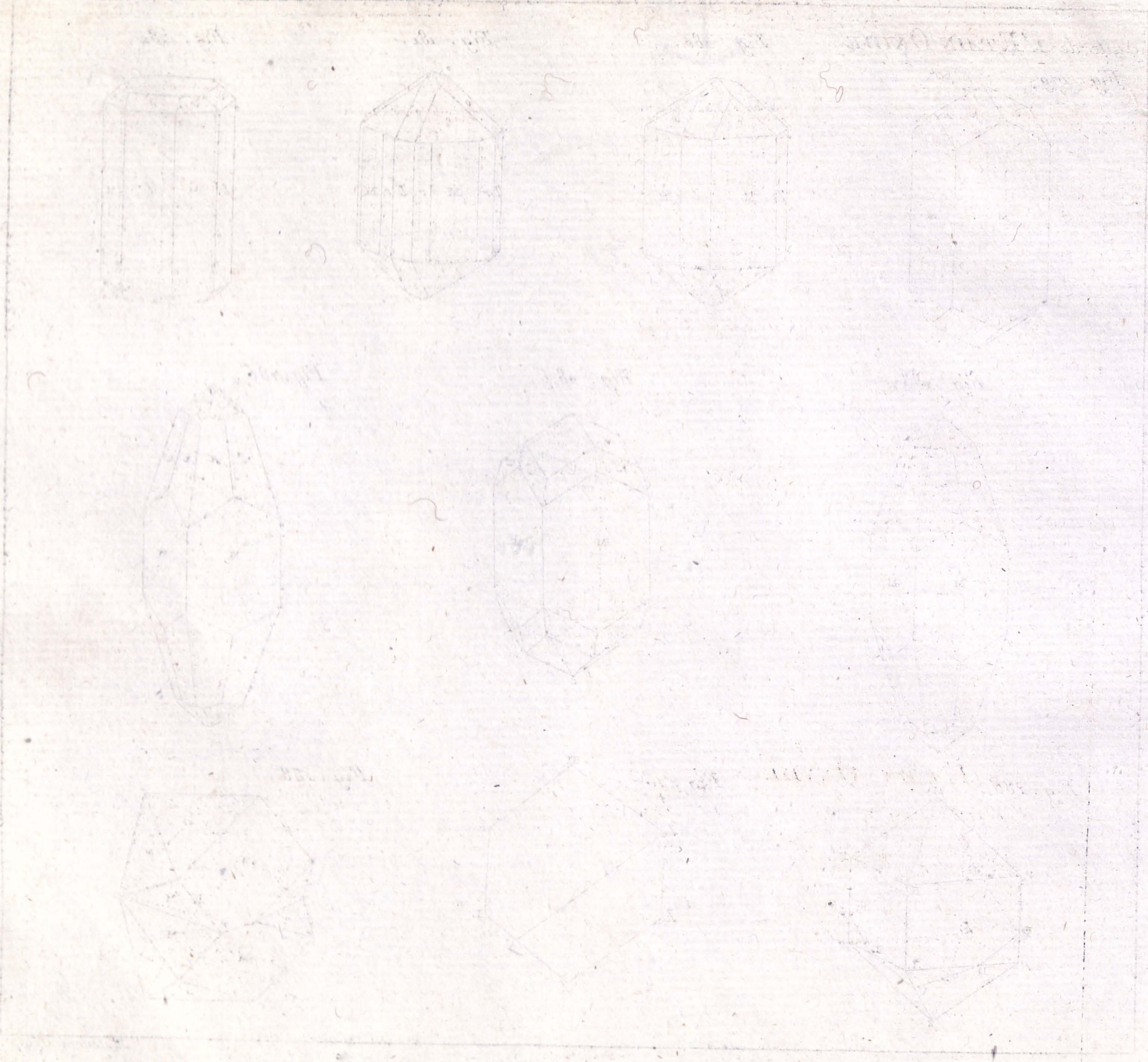

Suite de L'ETAIN OXIDE

Fig. 179.

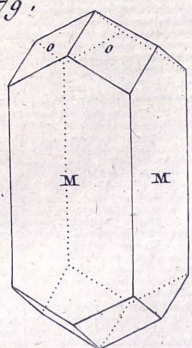

Fig. 180.

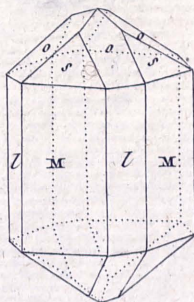

Fig. 181.

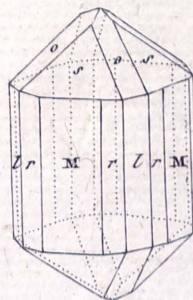

Fig. 182.

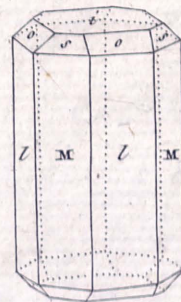

Fig. 183.

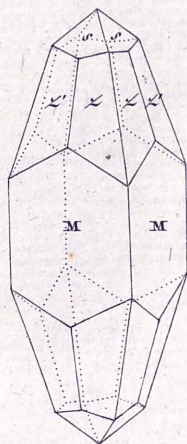

Fig. 184.

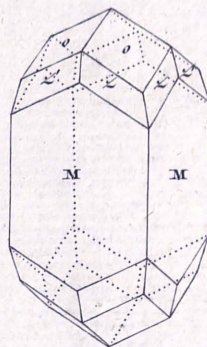

Fig. 185.

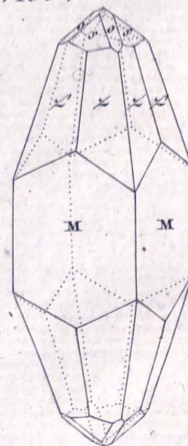

Fig. 186.

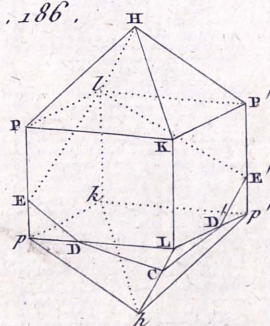

Fig. 187.

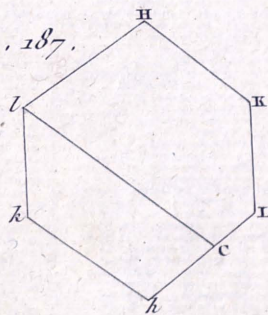
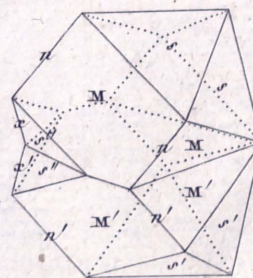
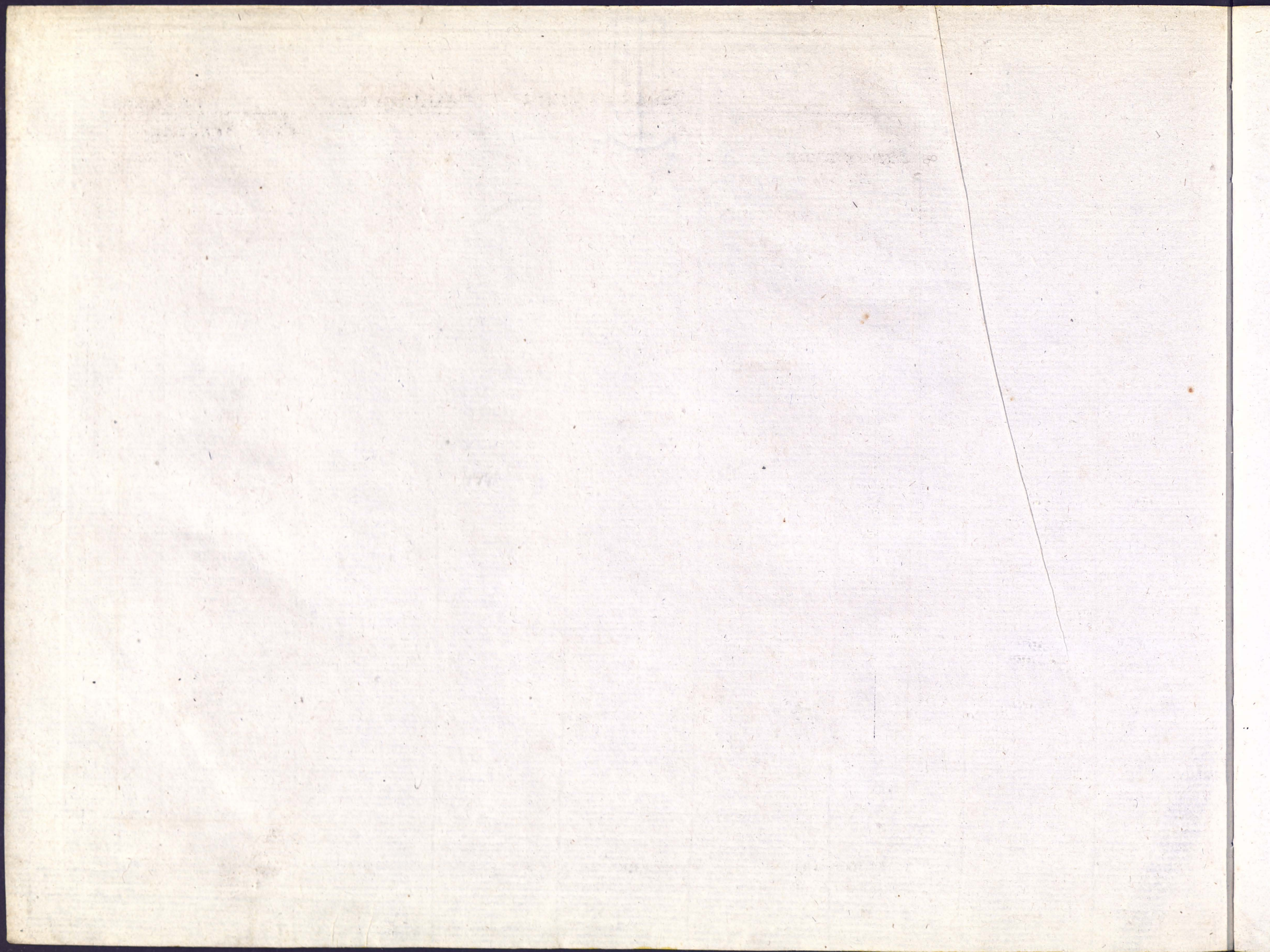

Fig. 188.





ZINC OXYDE

Fig. 189.

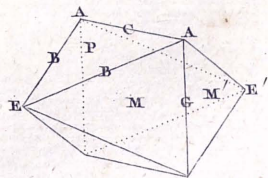

Fig. 190.

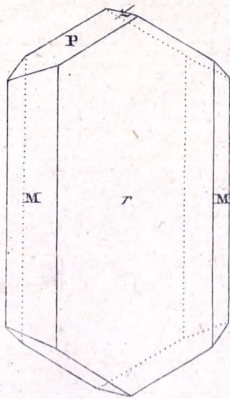
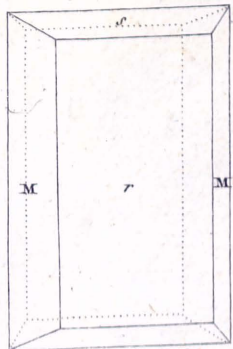

Fig. 191.



ZINC SULFURE

Fig. 192.

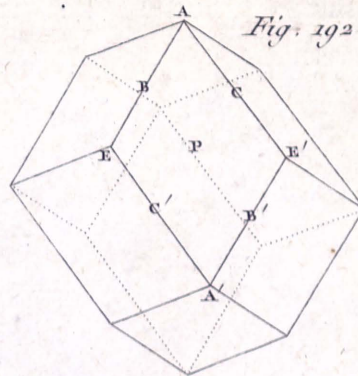

Fig. 193.

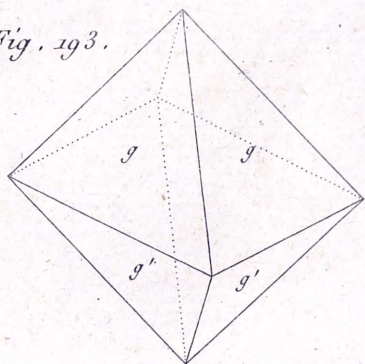

Fig. 194.

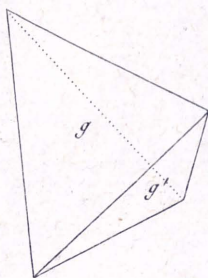

Fig. 195.

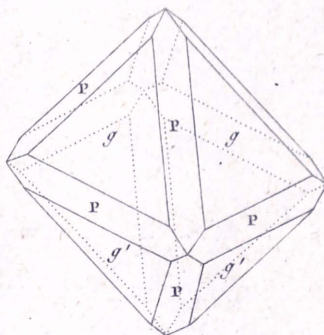

Fig. 196.

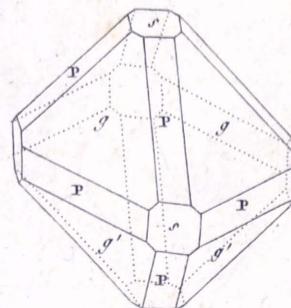

Fig. 197.

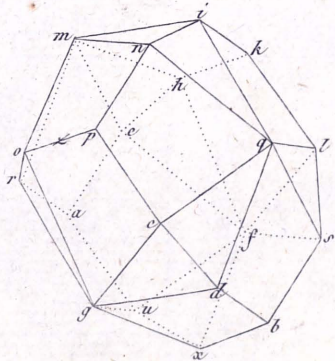

Fig. 198.

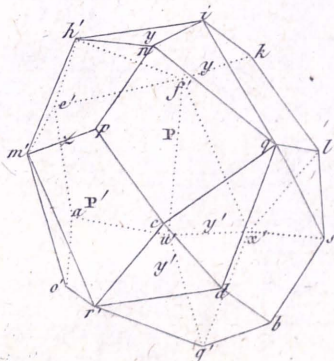
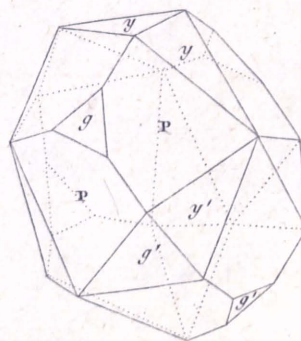

Fig. 199.



PL. 187

PLANTAS DE LA SIERRA DE

PLANTAS DE LA SIERRA DE

PLANTAS DE LA SIERRA DE

PLANTAS DE LA SIERRA DE

PLANTAS DE LA SIERRA DE



ZINC SULFATÉ

Fig. 200.

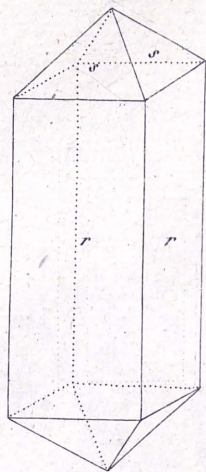

MANGANÈSE OXYDÉ

Fig. 201.

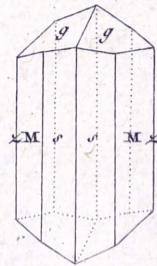
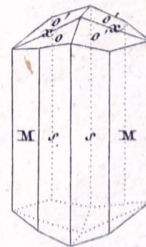
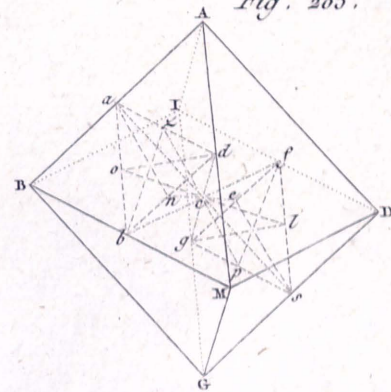

Fig. 202.



ANTIMOINE NATIF

Fig. 203.



ANTIMOINE SULFURÉ

Fig. 205.

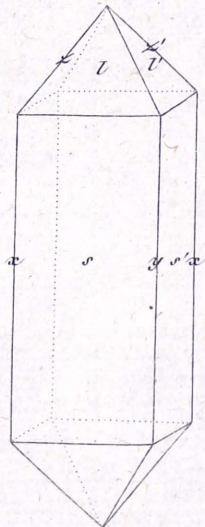

Fig. 206.

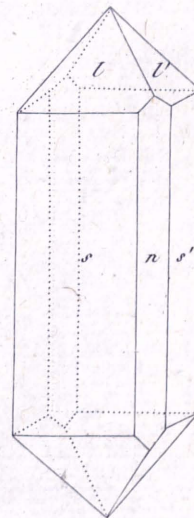

Fig. 204.

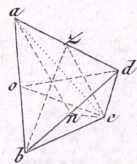
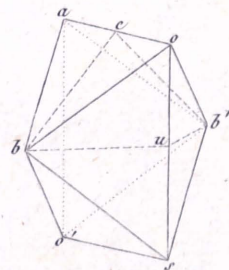
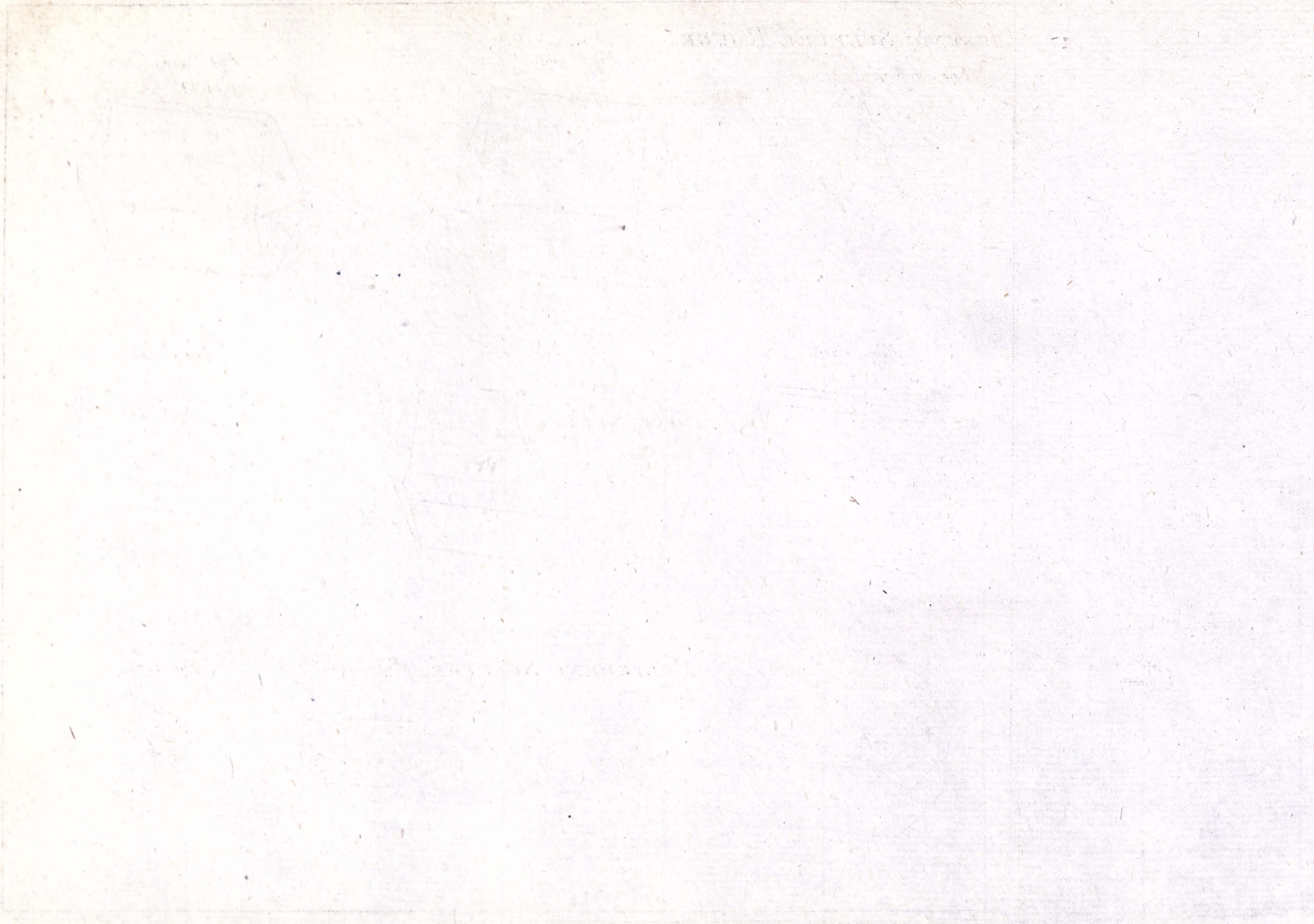

Fig. 207.





ARSENIC SULFURÉ ROUGE

Fig. 208.

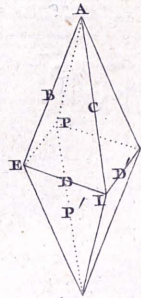

Fig. 209.

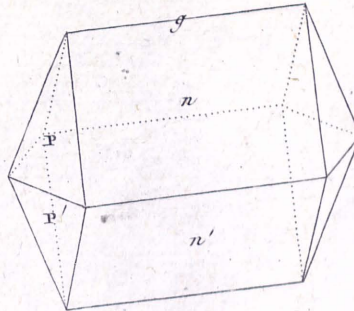

Fig. 210.

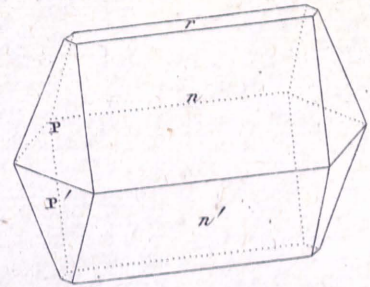

Fig. 213.

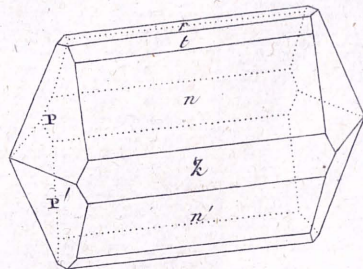

Fig. 211.

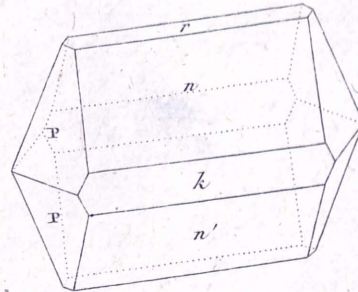

Fig. 212.

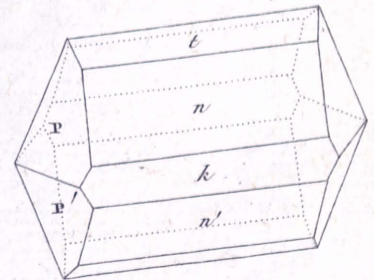
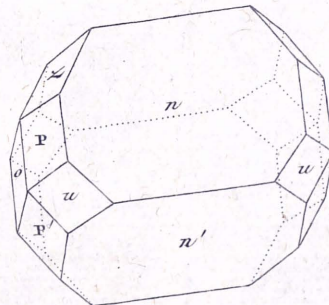

Fig. 214.



MOLYBDÈNE SULFURÉ Fig. 216.

Fig. 215.

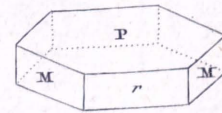
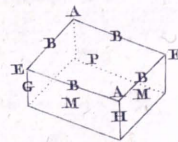
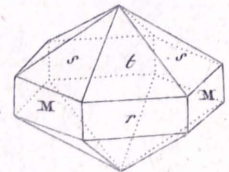

Fig. 217.



DEUTSCHLANDS - VERFAHREN

1. 1800

2. 1800

3. 1800

4. 1800

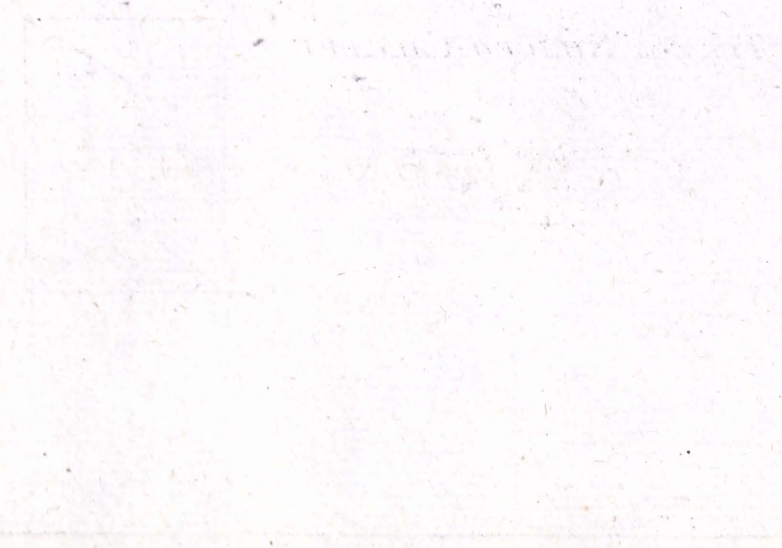

TITANE OXYDE'

Fig. 219.

Fig. 220.

Fig. 221.

Fig. 218.

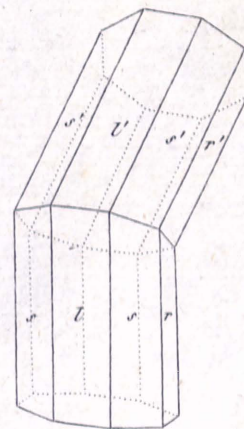
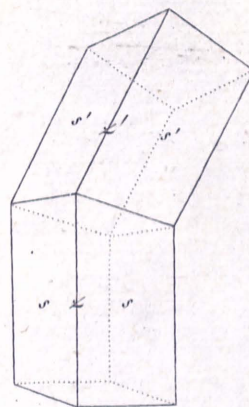
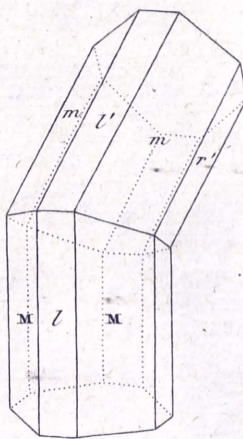
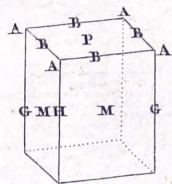
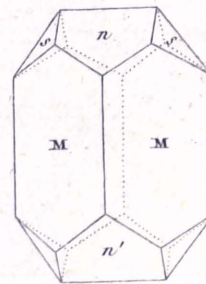
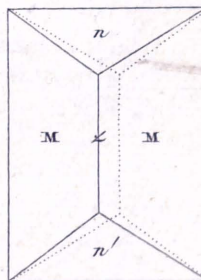
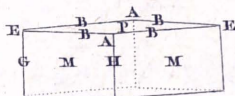
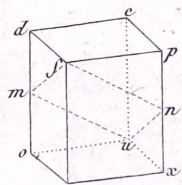

Fig. 222. TITANE SILICEO-CALCAIRE

Fig. 223.

Fig. 224.

Fig. 225.





SCHEËLIN FERRUGINE

Fig. 226.

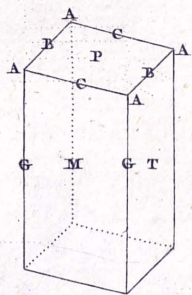

Fig. 227.

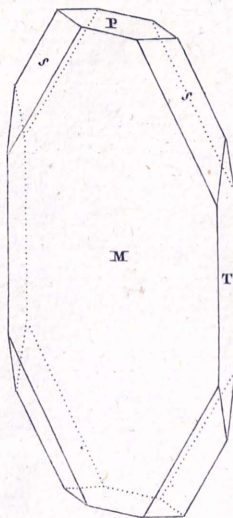

Fig. 228.

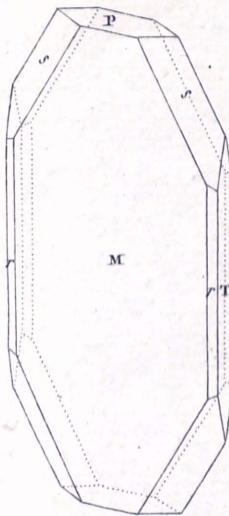
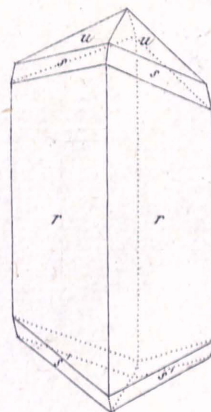

Fig. 229.



SCHEËLIN CALCAIRE

Fig. 230.

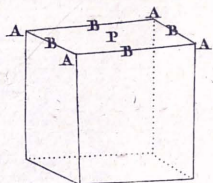
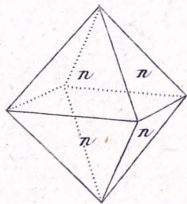

Fig. 231.



I^{ER} APPENDICE. ARRAGONITE

Fig. 232.

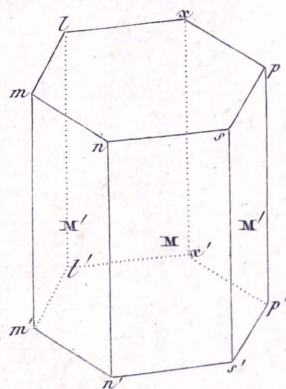
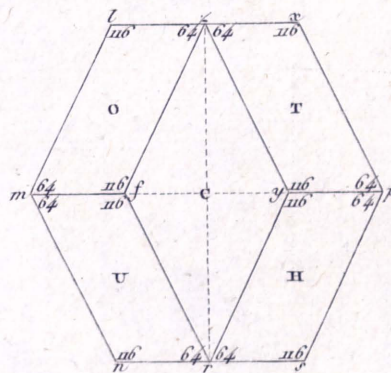

Fig. 233.



THE UNIVERSITY OF CHICAGO

LIBRARY

1911

PHYSICS DEPARTMENT



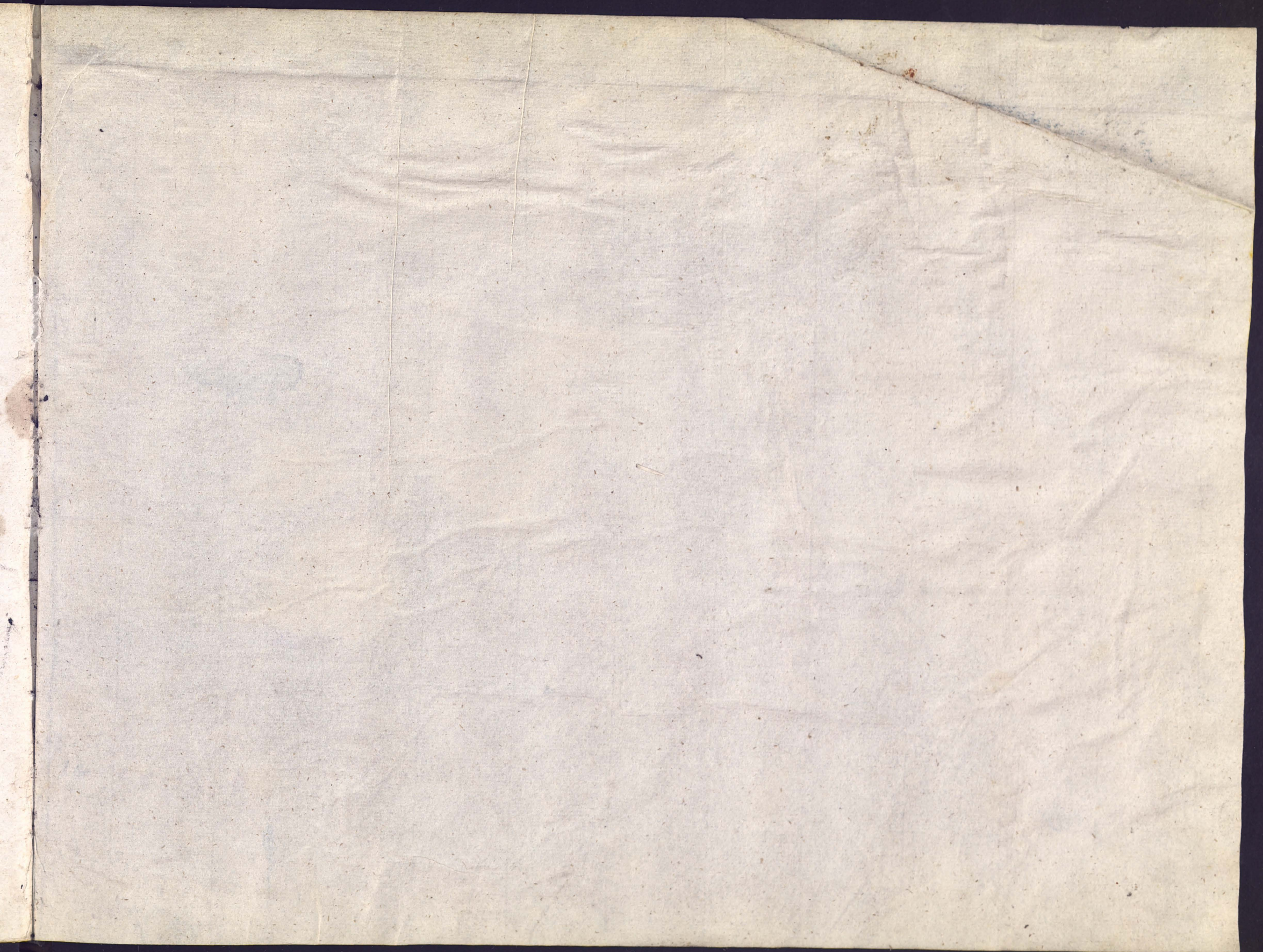

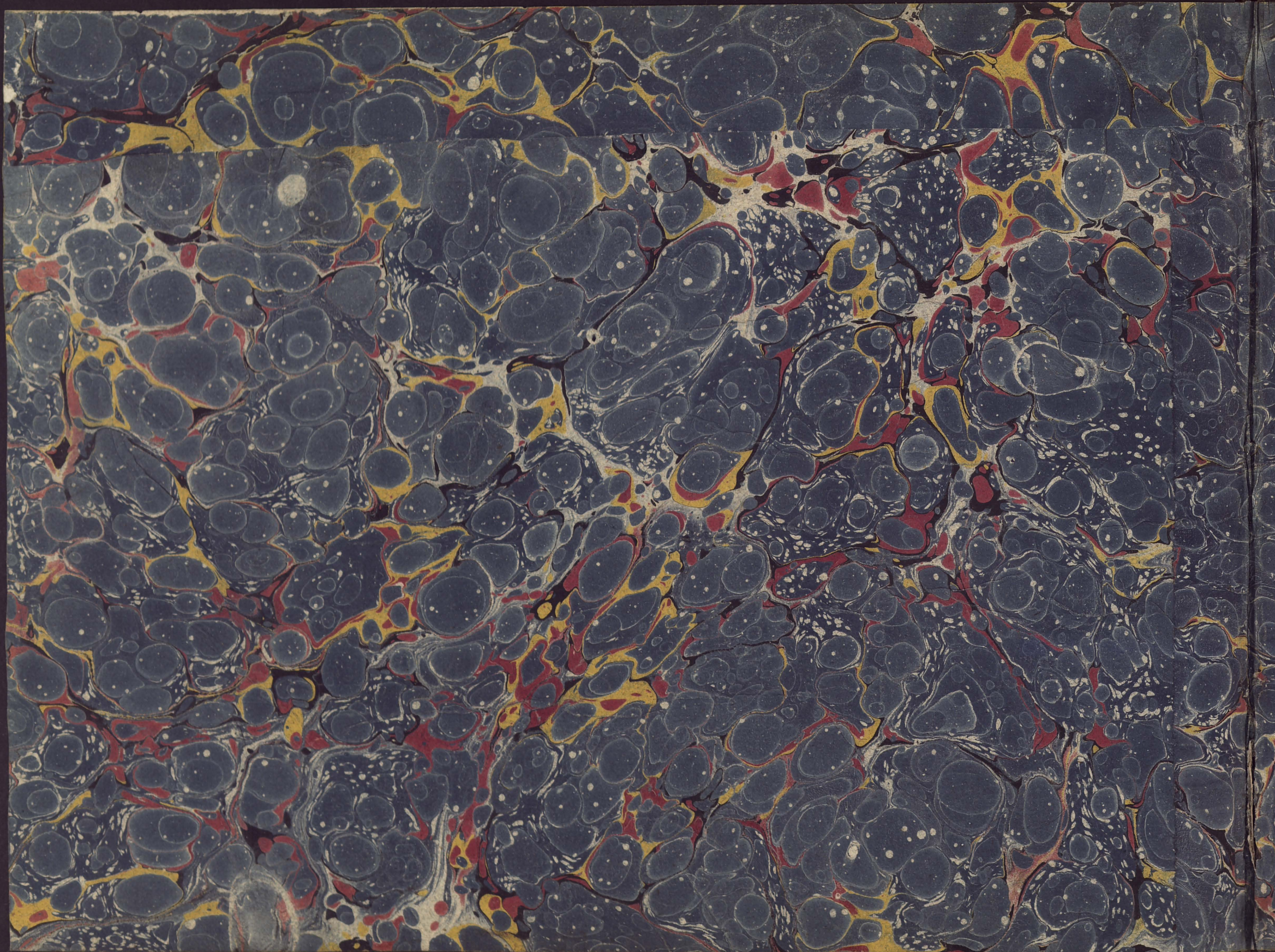

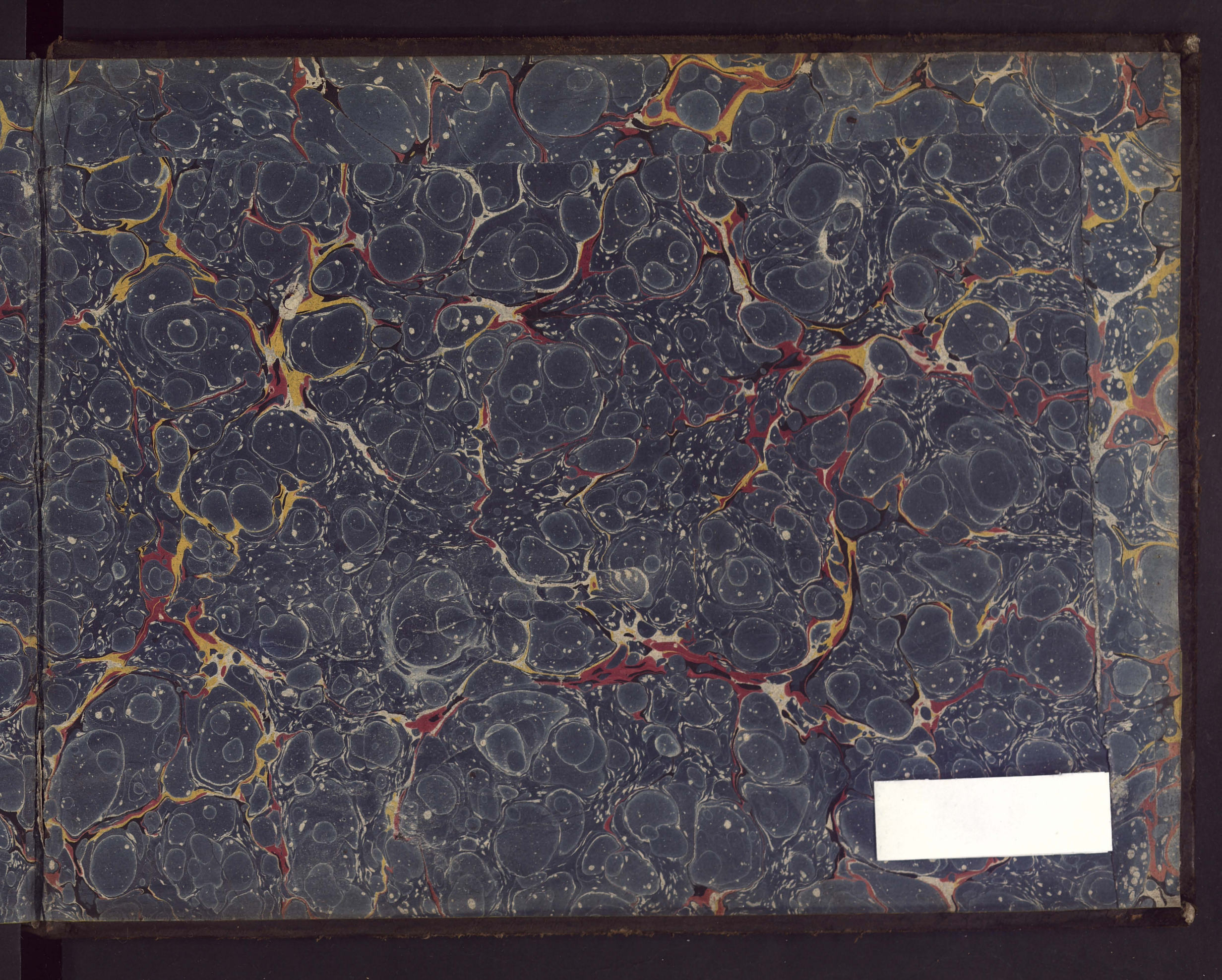

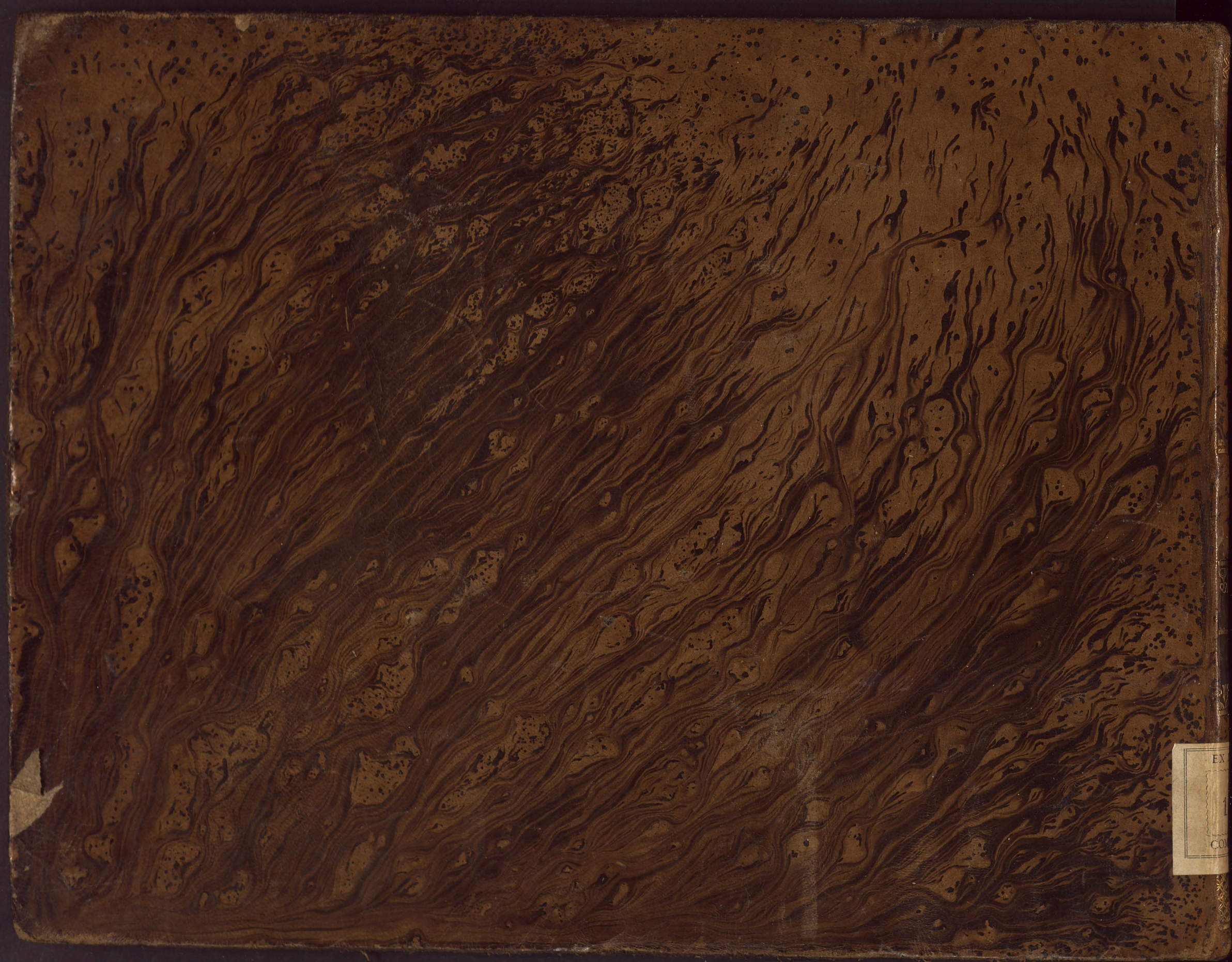

EX
1
CO